



YILDIZ TECHNICAL UNIVERSITY

**METALLURGICAL AND MATERIALS
ENGINEERING DEPARTMENT**

MSE3952 LABORATORY II

EXPERIMENTAL BOOKLET

2022-2023

SPRING

Table of Contents

Important Information	3
Experiment 1: Precipitation Hardening	4
Experiment 2: Mineral Processing (Ore Dressing)	8
Experiment 3: The Sol-Gel Technique	16
Experiment 4: Recycling	26
Experiment 5: Bioceramic Scaffold Production	32
Experiment 6: Production of Composite Materials	43
Experiment 7: Reduction Electrolysis	50
Experiment 8: Recrystallization	58
Experiment 9: Hardening	62

IMPORTANT INFORMATION

- 1) There will be 9 experiments during the term.
- 2) The student who does not come for the experiment for two weeks will be considered absent.
- 3) There will be no experiments during the midterm week.
- 4) Experiments not attended will be evaluated as zero.
- 5) A single experiment will be conducted each week and all students will enter the experiment at the same time. Experiments will be conducted online.

Experiments will not be repeated.

- 6) A quiz will be given before the experiment. Quizzes will be defined separately for each experiment at <https://online.yildiz.edu.tr> (Online education system).

It is your responsibility to take the exam at the specified date and time. Excuses will not be accepted.

Quiz Time for all experiments: 15.05-15.15

- 7) The average of the quiz exams held before the experiment will be 30% of the midterm average.
- 8) The report of the experiments will be prepared individually and according to the format shared with you.

Reports that are not prepared in accordance with the format will not be evaluated. Similar reports will be evaluated as "ZERO".

- 9) Homework will be defined separately for each experiment at <https://online.yildiz.edu.tr> (Online education system) and reports will be uploaded to the system individually between the specified dates.

Reports sent by mail will not be accepted regardless of the excuse.

- 10) The average of the reports will be 20% of the midterm average.
- 11) You must be a participant in the experiments. Course attendance time is measured by the system for each student. **Your participation in the class and the length of time you attend the class will determine your performance.**
- 12) The performance grade point average will be 10% of the midterm average.

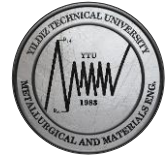

EXPERIMENT 1: PRECIPITATION HARDENING

1. PURPOSE OF THE EXPERIMENT

The primary purpose of the precipitation hardening experiment is to examine the effect of the applied process on the mechanical properties (strength, hardness, etc.) of materials that can respond to heat treatment (such as 2xxx, 6xxx, and 7xxx series aluminum alloys).

Improving the mechanical properties of the material with thermal methods without changing the chemical composition

2. THEORETICAL INFORMATION

The mechanical properties of materials are largely dependent on their internal structure. Since the internal structure is related to the chemical composition and the mechanical or heat treatments applied to the material, it can be said that the mechanical properties of the materials also depend on these factors. In this context, strength is one of the most important mechanical properties of a material and is expressed as "resistance to plastic deformation". Plastic deformation of metals is mainly caused by the progression of linear defects called dislocations in the crystal. Therefore, mechanical properties such as strength, hardness, and ductility are explained by both the density of the dislocations in the internal structures of metals and their interactions with other components and defects. Any factor that will complicate or prevent the movement of dislocations in the internal structure of metals will lead to an increase in the strength of the material. Conversely, any factor that will facilitate dislocation movements will enable plastic deformation to occur more easily.

There are various methods used to strengthen metallic materials. The main ones can be classified as; Strain hardening, Alloying, Grain size reduction, Martensitic transformation hardening, Precipitation hardening, etc. With the development of technology and due to its technical features, aluminum, which is one of the youngest members of the global metal world, is widely used in many areas of the industry. In practice, aluminum, which has a very high strength-to-weight ratio and is quite light compared to steel; has become especially attractive for industries such as automotive, and aerospace industries, since its mechanical properties can be increased to a level comparable to steel when it is doped by the addition of alloying elements [1].

Heat treatment generally includes heating and cooling processes applied to metallic materials to change their mechanical properties. In this context, precipitation hardening/aging heat treatment can be applied to suitable aluminum alloys. Aging can only occur in alloys with a solvus curve in the equilibrium diagram, and solid solution compositions are limited only by the solvus curve. Elements such as Cu, Zn, Mg, and Si added into Al alloys make this alloy applicable for precipitation hardening with the intermetallic structures they form in the primary phase [2]. Therefore, precipitation hardening heat treatment can be applied to 2xxx (Al-Cu), 6xxx (Al-Mg-Si), and 7xxx (Al-Zn-Mg) series aluminum alloys. The phase diagram of the 2xxx series Al alloy, which can be applied to precipitation hardening heat treatment, is given in Figure 1. Thanks to the precipitation hardening process, it is possible to develop light and high strength-to-weight Al alloys suitable for use in the aerospace industry.

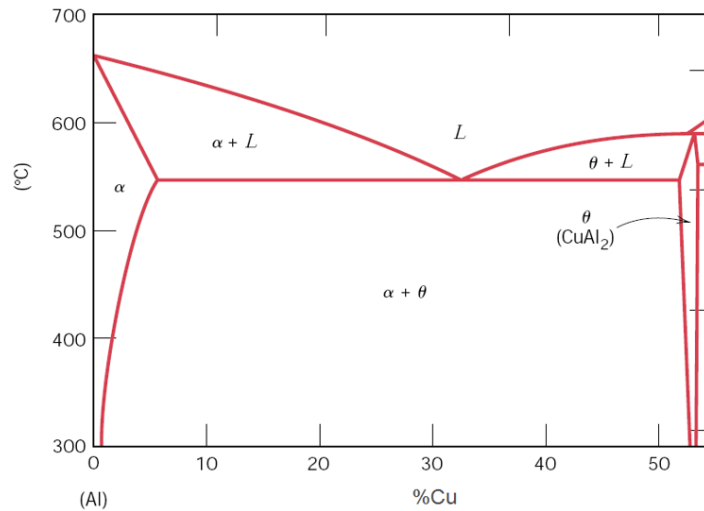
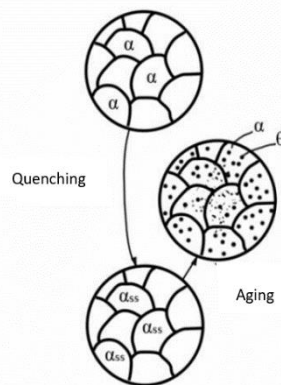
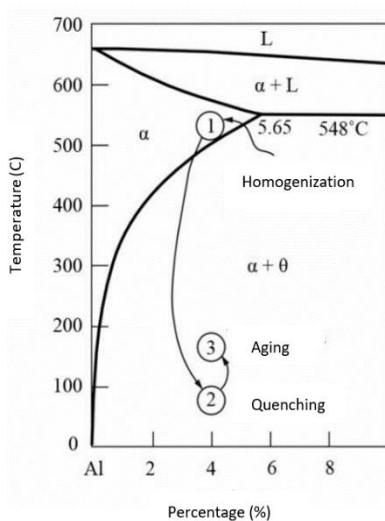

Figure 1. Phase diagram of 2xxx series Al alloy that can be precipitation hardening heat treatable.

The first precipitation hardening application for an increase in strength and hardness of Al alloys was examined by Alfred Wilm in the early 20th century (1906). Alfred Wilm, in his studies on aluminum alloys, observed that duraluminum gained hardness as a result of sudden cooling from high temperature (quenching) and waiting at room temperature, just like steel. The increase in hardness of the aluminum alloy known as duraluminium (Al-4.4%Cu-1.5% Mg-0.5%Mn) as a result of quenching and waiting at room temperature is called natural aging. Waiting for a certain period of time at a temperature between 100°C-300°C after quenching is called artificial aging. It has been revealed in later studies that the aging time is shortened by increasing the aging temperature. However, if the aging temperature is too high or the aging time is too long, in this case, the so-called over-aging phenomena occur and a decrease in material strength is observed again [3]. On the other hand, the type, distribution, amount, average diameter, and number of the precipitated second phases affect the strength of the material.

The precipitation hardening heat treatment is conducted in three stages:



1. Solution Treating: High-temperature annealing

(Homogenization process) in order to homogenize the alloy

2. Quenching: Obtaining supersaturated structure with sudden cooling in a water environment (α_{ss})

3. Aging (Natural/Artificial):

Aging for a certain period of time at a temperature below the homogenization temperature (100-300°C)

Figure 2. Precipitation hardening process steps and the changes in microstructure [4]

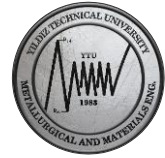

The precipitation hardening process steps and changes in the microstructure are given in Figure 2 [4].

3. TOOLS, DEVICES and MATERIALS

- Samples of 6xxx series aluminum alloy,
- Oven that can reach an elevated temperature for solution treating,
- Sudden cooling (Quenching) environment,
- An oven that can be heated to 300°C for artificial aging,
- Brinell hardness device.

4. EXPERIMENTAL STUDIES

As the test sample, 6xxx series Al alloy with a thickness of at least two mm and containing Al-Mg-Si was preferred. Within the scope of the experiment, four samples are used to determine the effect of aging time on the hardness of the material.

In the first stage of the experiment, all samples are placed in the oven at 530-550°C for approximately 30 minutes to apply "Homogenization annealing". After the period specified, as the second stage, the samples are taken out of the furnace as quickly as possible and instantly cooled in a water environment to ensure "sudden cooling".

One of the samples is separated so that the hardness can be measured without applying artificial aging, and the other three samples are subjected to artificial aging for the specified periods in an oven at approximately 200°C. For measuring the hardness, the samples are taken out of the oven at the end of the applied aging period and cooled rapidly. Hardness measurement should be done quickly, as the time spent outside the oven will affect the result. Hardness measurements are carried out by using a Brinell hardness measuring device.

5. RESULTS and DISCUSSION

The formula to be used in the determination of the Brinell hardness values is given in Equation 1.

$$HB = \frac{F}{2 \times \pi \times D \times (D - \sqrt{D^2 - d^2})} \quad (1)$$

F: Force (N,kg), *D*: Ball diameter (mm), *d*: Mark diameter (mm)

In order to make comparisons by using the data obtained as a result of the experiment, a hardness-aging time graph will be created.

6. INFORMATION REQUIRED IN THE EXPERIMENT REPORT

- **Cover Page:** In accordance with the format; Emblem, Course Information, Supervisor of the Experiment, Student Name-Surname/Student Number, and Group Number
- **Theoretical Information:** An original summary of the knowledge conveyed on the relevant subject during the experiment, prepared by the student
- **Experimental Studies:** Materials and equipment used in the experiment; The procedure steps explained in accordance with the application conditions and the order of the experiment (with cause and results); Brinell hardness calculations (with units)
- **Evaluation:** Drawing of Brinell Hardness-Aging Time graph and interpretation by the student.

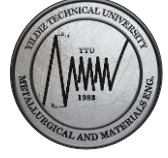

7. REFERENCES

- [1] GÜVEN, Ş. ve DELİKANLI, Y., (2012). "AA 2024 Alüminyum Alaşımında Çökeltme Sertleşmesinin Mekanik Özelliklere Etkisi", Teknik Bilimler Dergisi, 2: 13-20.
- [2] YAMAN, M.B. KOCAMAN, E. ve Barış, A., "Al7075 Alaşımına İlave Edilen Al-5Ti-1B Tane İncelticinin Yaşlanma, Mikroyapı, Sertlik ve Korozif Özellikleri Üzerindeki Etkisi", Gazi University Journal of Science Part C: Design and Technology, 10: 870-883.
- [3] YAŞAR, A.C. ESER, A.A. ÖZCAN, A. ve ACARER, M., "ALÜMİNYUM DÖVME VE EKSTRÜZYON ALAŞIMLARINDA AŞIRI YAŞLANDIRMANIN MİKROYAPI ve MEKANİK ÖZELLİKLERE ETKİSİ".
- [4] AL-SAADI, H.I.A. ve TUNAY, R.F., (2017). "Suni Yaşlandırma İşleminin Alüminyum Alaşımının Sertliği Üzerine Etkisi", Mühendislik Bilimleri ve Tasarım Dergisi, 5: 525-532.

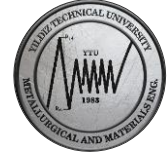

EXPERIMENT 2: MINERAL PROCESSING (ORE DRESSING)

1. OBJECTIVE OF THE EXPERIMENT

In this experiment, it is aimed to investigate the crushing, grinding and separation steps according to the size of the ore preparation, the determination of the process parameters and also the flotation process which is one of the ore enrichment processes.

2. THEORETICAL INFORMATION

2.1 GENERAL TERMINOLOGY ON ORE DRESSING

Ore: The rock that is made up of one or more minerals, which are economically valuable and can be consumed directly or after some beneficiation operations, in industry. Ore is the raw material of metal production. If valuable minerals do not contain metallic elements, it is called industrial raw material instead of ore dressing.

Mineral: A mineral is a naturally formed solid and inorganically crystallized structure that has a homogeneous, specific chemical composition and a specific crystal structure.

Concentrate: It is a product obtained by beneficiation of minerals which are formed as a result of ore dressing or beneficiation processes and which are aimed to be separated from raw ore.

Tenor: Percentage of metal or economically valuable minerals in an ore.

2.2 ORE DRESSING AND BENEFICIATION

The process of raising the percentage of the base metal mineral in the low grade ore occurring in nature. By taking advantage of the different properties of the gangue minerals and the base metal mineral, minerals are partially separated from each other by ore dressing or beneficiation process.

Ore dressing is applied due to economic and technological reasons.

a) Technological Reasons for Ore Dressing

Some ores need to provide certain conditions (grain size, grade and element content) in order to be technologically produced. Examples of these conditions are given below.

Example 1. For quartz sand in glass making; $0.1 \text{ mm} < \text{Grain Size} < 0.5 \text{ mm}$ and $\% \text{Fe}_2\text{O}_3 < 0.05\%$ are required.

Example 2. For iron ore used in pig iron production; $10 \text{ mm} < \text{Grain Size} < 100 \text{ mm}$ is required. For this purpose, crushing, grinding and sintering-pelletizing is applied. In addition, both $\% \text{P}$ and $\% \text{Na}_2\text{O}$

+ K_2O must be $< 0.1\%$.

Example 3. In order to produce calcined magnesite or sinter magnesite at high quality from magnesite ore: $\text{SiO}_2 < 0.5 \%$ and $2 \text{ mm} < \text{Grain Size} < 30 \text{ mm}$ are required.

b) Economic Reasons for Ore Dressing

There are basically two reasons:

a) Using an uneconomic ore directly as is produced from the quarries (eg, producing lead metal directly from a 5 % Pb-containing ore) is never economical. With the ore dressing process, the lead percentage is increased to 60% and economic efficiency is ensured.

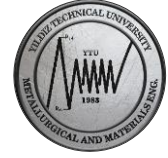

b) To further increase the economics of an economic ore as produced from the quarries.

For example, it is economical to produce pig iron directly from a 50 % Fe-containing ore, but increasing the iron tenor to over 50 % further increases the economics.

2.2.1 ORE DRESSING PROCESSES

Crushing: It is the coarse size reduction carried out with the help of crushers. It is applied in two stages; coarse crushing (average 100 mm grain size) and fine crushing (1-10 mm grain size).

GRINDING: It is the fine size reduction carried out with the help of mills (below 0,1 mm grain size).

SCREENING: It is the dimensioning done with the help of screens.

SEPARATION BY SIZE: Minerals are separated from each other partially by using density, magnetic, electrical and surface properties.

2.2.1.1 CRUSHING

Crushing is the first step of size reduction. It is conducted to make one of the different minerals freed from others, the process is done with the aim of providing suitable size or surface area or suitable size for the purpose of use.

The forces applied in the field; impact, compression or crushing, cutting and friction forces. The devices used for crushing are called crushers. They are mechanical tools that apply pressure, impact and shear force to the grain to bring them to a smaller grain size.

Crushing machines are developed especially in terms of design features such as product characteristics, machine costs and energy use. Thus ore dressing machines in a variety of shapes, structures and sizes are used.

Crushing is applied to grain sizes between 200 and 0.5 cm. Crushing between 200-10 cm is named coarse crushing; and crushing between 10-0.5 cm, it is called fine crushing. Jaw, cone and hammer crushers are the most widely used types of crushers in ore dressing plants.

Removal of the crushed material in the desired size from the crushing cycles or classification of the material according to the size; different sieves are used according to the applied process, structure of the ore, size, physical and chemical properties. These are classified as; according to the structure of the sieve surface sheet, parallel bar screens, and wire mesh;; according to their working stationary (fixed grid and stationary arched sieve) and moving (traveling grate, rotary screen, shaking screens and vibrating screens).

2.2.1.2 GRINDING

Grinding is the final stage of size reduction after crushing. The process is conducted with the aim of freeing one of the various minerals from others in the ore, providing suitable size or surface area or requested size for the purpose of use. The forces applied in grinding are; impact, compression or crushing, cutting and friction forces.

The devices used for grinding are called mills. The mills are selected according to the type of the ore, size of the desired product in the grinding cycles or after grinding. **Ball and rod mills** are the most commonly used in ore dressing plants. Grinding is carried out as wet or dry depending on the flow of the process and the state of the ore. According to the grinding scheme, the classifier and other process machines in the system are selected. Dry grinding requires about

1.3 times more power than wet grinding. For removal from grinding circuits or classification according to the size of the material; different classifiers are used according to the applied process, structure of the ore, size, physical and chemical properties. These are known as; hydrocyclones, mechanical classifiers (spiral classifiers, notched classifiers, solid centrifugal classifiers) and air classifiers.

2.2.1.3 SCREENING

Screening is the process of separating a solid material mixture into components of different dimensions using screens. According to the screen size used in the sieving classifying "mesh number" concept is used. Mesh number indicates the number of holes per unit area (in^2 or mm^2) of a screen.

By sieving, two types of products are obtained, one screen underflow (subsieve) and oversize (oversieve). Industrial sieves are divided into two main divisions: "fixed sieves" and "moving sieves", depending on whether the surface of the workpiece is fixed or movable. The simplest forms of fixed screens are grids. Grids are the most suitable type for large sized items. They are usually made oblique and allow the pieces falling from the grid spacing to separate from the grid as the material on them moves down. various motions are given to the grid to reduce clogging in the moving screen. With these movements, material is pushed in one direction and sieving is facilitated.

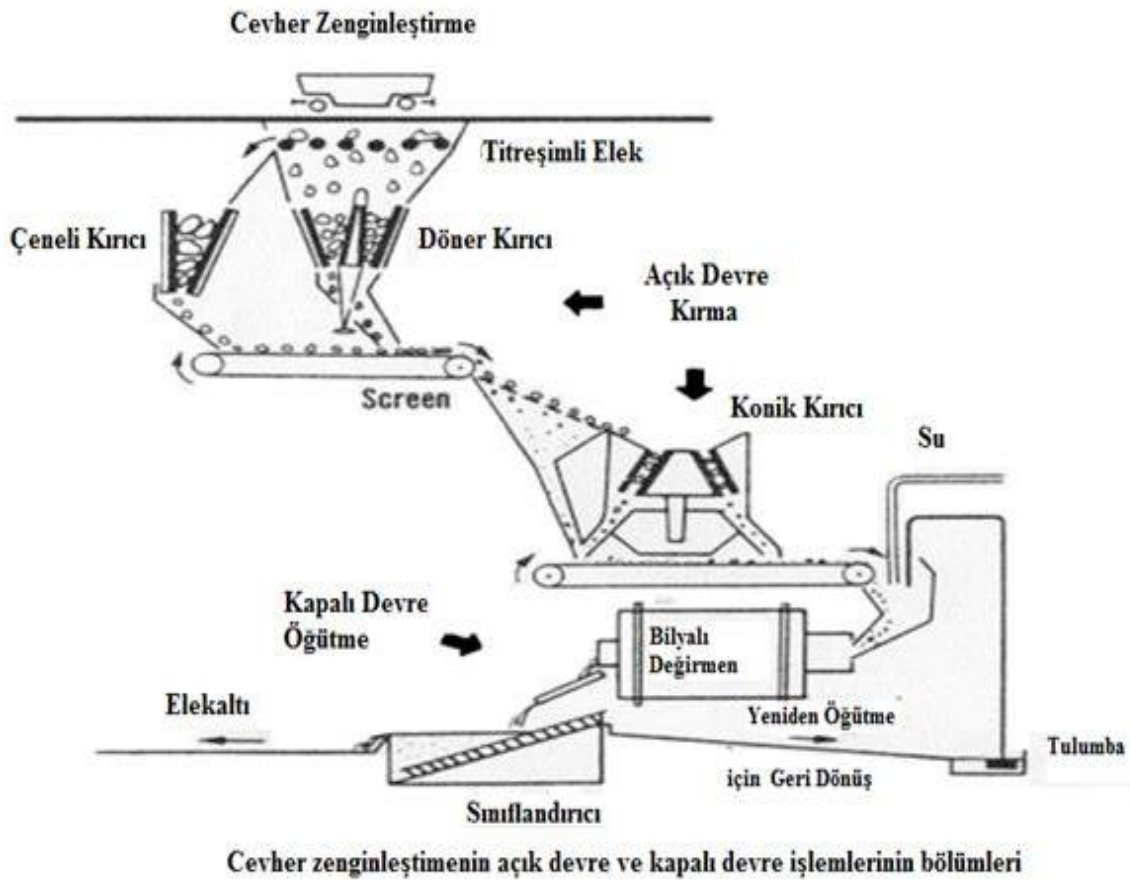

2.2.2 FLOTATION

Flotation is derived from the word float. In the ore beneficiation processes, flotation is a method of separating some minerals in an ore from other minerals sunk in the water by floating and removing some of them from the water. In this process, the separation is made by using the differences in the surface properties of the minerals.

Wetting of particles is known to be one of the important parameters affecting many technological processes such as wetting, flotation, agglomeration, solid-liquid separation and dust suppression. In the flotation system consisting of solid, liquid and gas phases, if the solid phase prefers the gas phase relative to the liquid, it is called hydrophobic, if liquid phase is preferred to gas phase, it is called hydrophilic. Hydrophobic minerals are low surface-energy minerals (coal, graphite, sulfur, talc, etc.). The wettability / hydrophobicity and buoyancy properties of the solids were investigated in terms of solid-water and solid-water vapor interfaces, chemical bonds, bulk properties, crystal structure of the solids and reactivity of the solids with water.

The high contact angle (θ) in the solid, liquid and air triple system means that the wetting of the liquid by the liquid is minimal. The forces in the solid, liquid, air triple system are as shown in Figure 2. The case where the triple phase is balanced is expressed by Young Equation.

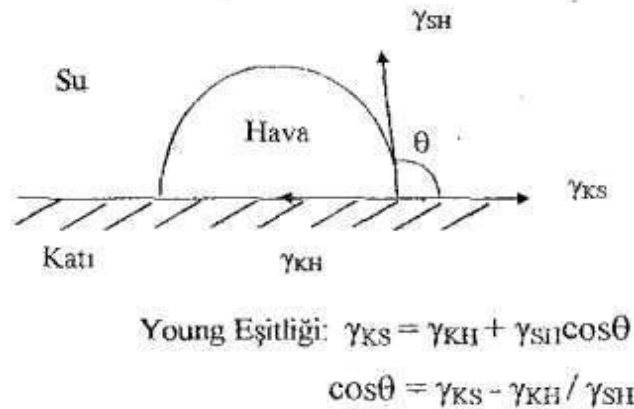
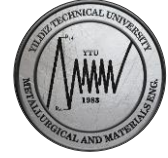

Figure 2. The forces in solid, liquid, air triple system and Young Equation

It is possible to determine the wetting and buoyancy characteristics of minerals or associations by several methods, empirical and empirical. The numerical value parameter obtained from these techniques is the critical wetting surface tension, γ_c . At low liquid surface stresses lower than this γ_c , the mineral loses its hydrophobicity or buoyancy property by being completely wetted by this solution. The surface tension (γ_{SH}) of the liquid used for a good contact angle (between solid-liquid-air interfaces), ie $\theta > 0$, must be greater than the γ_c value of the mineral. This is the first of the conditions required for the successful flotation.

Low surface energetic minerals ($\gamma_c < 72 \text{ dyn / cm}$) are wetted by surface-energized fluids lower than the Critical Wetting Surface Energy (γ_c). Selective separation of the two layers in the flotation system is based on whether one of the solids is partially wetted by the flotation solution or completely wetted by the solution while the other layer is not wetted ($\theta = 0$ state). Partially wetted solids clinging to the floating air bubbles.



Two of the most commonly used techniques for measuring the hydrophobicity of minerals or solids, and therefore the wetting of the γ_C value that determines good flotation, are the "contact angle measurement method" and the "flotation method".

Application areas of flotation for ore dressing are;

- Flotation of metallic ores
- Flotation of non-metallic ores
- Cleaning of solid fuels

The advantages of flotation are;

- Beneficiation of very fine grained ores
- Beneficiation of complex ores
- Control of the product tenor as desired
- Insignificance of specific weight difference of minerals.

The disadvantages of flotation are;

- High costs compared to gravity and magnetic separation methods
- Because of the excessive grinding of the ore, sometimes the loss of metal is high and the grinding costs increase
- Causing environmental pollution

2.2.2.1. Reagents Used in Flotation

Various reagents are added to the flotation medium in order to float or suppress the desired mineral(s) in the flotation. It is possible to sort these reagents as follows.

Collectors: It is a chemical substance that imparts hydrophobicity to surfaces by modifying surface properties through adsorbing to the surfaces of mineral(s).

Frothers: These are foam forming chemicals in flotation circuits. The main goal of the foaming agents is to be able to form a foam of sufficient volume and strength. Foams should be able to explode easily after exiting the flotation cell.

Control Reagents: reagents that are used to adjust the flotation conditions.

i) **Suppressor Reagents:** These are the flotation reagents are used to suppress unwanted mineral(s). These reagents reduce collector adsorption on the mineral surface.

ii) **Activating Reagents:** Reagents that increase collector adsorption to the surface of mineral(s).

iii) **Other Control Reagents:** Reagents in this group provide; regulation water hardness, bind the harmful ions for the flotation, flocculation or dispersion of some minerals in the pulp.

2.2.2.2. Flotation Machines

Flotation machines are usually composed of successive cells. the residue of previous cells is subjected to flotation in each cell. There is a connection between each cell, or a residual flow plate between cells. Air inlet and mixing operations to the pulp inside the cell are conducted by three types of methods;

- Self- aerated mechanical cell (Agitation)
- Air blown mechanically agitated cells (Sub-aeration)
- Air blown, air mixed cell (Pneumatic)

These properties are taken into consideration for the construction of various types of cells.

Currently the most used cell types in the industry are self- aerated mechanical cell types manufactured by companies such as Denver, Fagergren, Humboldt, Massco.

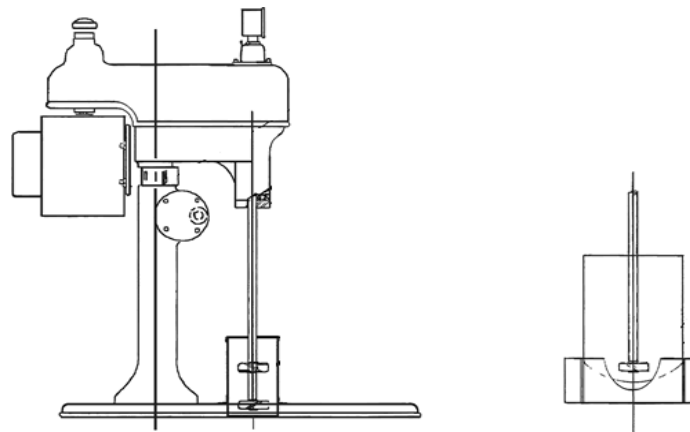
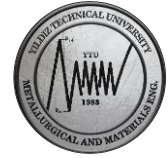

Figure 3. Denver flotation machine

3. EQUIPMENT AND MATERIALS

- Various Crushers and Mills
- Sieves and Screening Device
- Denver Flotation Machine
- Pipet, Washing Bottle, Enamel Containers
- Precise Balance
- Reagents (Collector, Frother)
- Ground Galena Ore



4. EXPERIMENTAL PROCEDURE

4.1 Ore Dressing Experiment

- ✓ The weight of the mixture to be examined for particle size distribution is weighed and recorded. The weighed mixture is fed to the crusher and crushing is performed by operating the crusher. After the crushed particles are removed from the crusher, they are weighed again and recorded.
- ✓ The sieves are arranged on the sieving device in the order of their interval, according to their mesh numbers. Then the crushed ore at the top of the sieve set is fed.
- ✓ The screws of the sieve set are squeezed and sieving is carried out by operating the device for ten minutes.
- ✓ By taking the sieve set from the machine, the amount of material left in each sieve and the total amount of sieved material are recorded in Table 1.1.

4.2 Flotation Experiment

- ✓ 200 g. of galena ore with $-200\ \mu\text{m}$ grain size is weighed and adjusted to 20% solids ratio depending on the volume of flotation cell. The cell is placed in the flotation machine and the pulp is mixed by starting the machine. The pulp is conditioned by stirring for 5 minutes.
- ✓ 1-2 drop of the appropriate collector used for galena ore, is added to the pulp and mixing is continued for 5 minutes.
- ✓ One drop of the frother, which provides for the formation of an aerosol foam for floatation of the hydrophobicized minerals, is added. After the addition of frother the pulp is conditioned for another 1-2 mins.
- ✓ After the end of the last conditioning period, the air inlet tap of the flotation device is opened and the pulp is aerated. Mineral(s), whose surface has become hydrophobic, adhere to the air bubble and accumulate on the surface as foam. Foams are removed from the surface and concentrated in a separate container, and the process is terminated after the extent of the mineral to be floated has finished.

5. ASSIGNMENTS

1. Write the objective and procedure of the experiment.
2. The results of each sieve analysis shall be recorded in the chart given in Table 1.1.

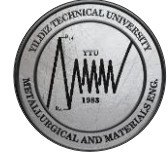

Table 1.1 Sieve analysis data and calculations

Sieve Dimension (mm)	Weight		Cumulative Oversieve %	Cumulative Subsieve %
	g	%		
Total				

3. By using the sieve analyzes obtained from the experimental procedure, sieve analysis charts of the input and output products will be formed and total subsieve and oversieve curves will be drawn.

4. Determine the average grain size from the intersection of the two drawn lines.

5. Find the theoretical average grain size by the formula given below and compare the theoretical grain sizes found at the intersection of the straight lines.

$$\text{Theoretical Average Grain Size} = \frac{\sum(x \cdot M)}{100}$$

X= Sieve interval or diameter (same as grain size), M=% grain class weight

6. The beneficiation ratio will be determined by weighing concentrate and residue after flotation. ($Z = \text{Ore Fed} / \text{Concentrate}$).

6. REFERENCES

- [1] Yiğit E., Cevher Hazırlama I, II ders notları, ZKÜ Yayını
- [2] KAYTAZ Y., “Cevher Hazırlama”, İTÜ Maden Fakültesi, 1990
- [3] ERGUNALP F. “Cevher hazırlama prensipleri” , İTÜ Yayınları, 1959
- [4] Zeki ÇİZMECİOĞLU, Üretim Metalürjisi Prensipleri Ders Notları, YTÜ, 2008

EXPERIMENT 3: THE SOL-GEL TECHNIQUE

1. PURPOSE OF THE EXPERIMENT

This experiment aims to provide professional knowledge about the sol-gel technique and gain hands-on experience in manufacturing materials with the sol-gel technique.

Within the scope of this experiment, the sol-gel technique will be introduced. Then ceramic-based nanopowder synthesis and the production of thin-film coatings will be carried out using the sol-gel technique.

2. THEORETICAL INFORMATION

The Sol gel method is a wet chemical process used in ceramic production. It was first discovered in the 1800s by Ebelman and Graham. From the 1930s on, Sol-gel was widely studied, and in 1938, the first patent on the sol-gel process in Germany was obtained. In 1943, Jenaer GlasWerk developed oxide coatings by the sol-gel method. It attracted attention when glass formation was achieved at room temperature in the 1970s. The sol-gel method comprises all systems where a suspension can be a gel. The sol-gel method can produce nano-dimensional ceramic powders, thin-film ceramic coatings, ceramic-based materials, and fibers [1-3].

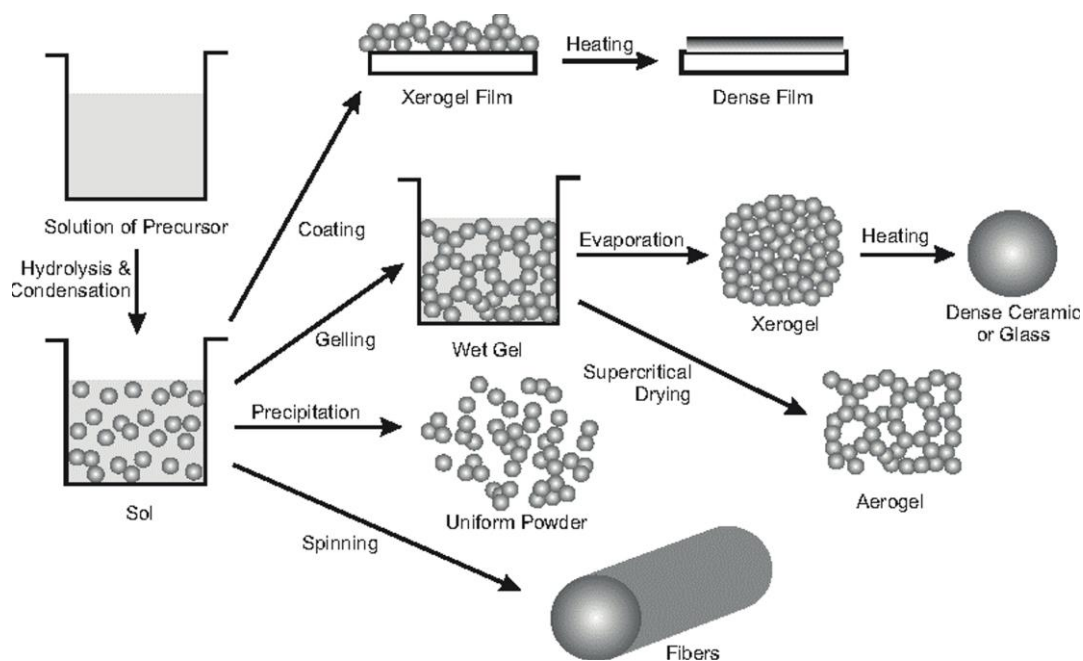

Figure 1. The Sol-Gel technology and products [2].

What is a Colloid?

A Colloid is a mixture of at least two phases (solid, liquid, or gas) in nano sizes. The colloid consists of a continuous phase and dispersion phases dispersed in this continuous phase. Continuous and dispersed phase combinations that may form colloids are listed below.

The liquid phase dispersed in the gas phase is also called aerosol. Example: Fog

Solid phase dispersed in the gas phase: Example: Sooty or smoky weather

Gas phase dispersed in the liquid phase: Foams. Example: Shaving foam, whipped cream

The liquid phase dispersed in the liquid phase is called the emulsion. Example: Paints

The solid phase dispersed in the liquid phase is called Sol. Example: Dyes

The solid phase dispersed gas phase is called solid foams. Pumice stone, polystyrene foam

The solid phase dispersed liquid phase is called gel. Gelatin, jelly

Solid phase dispersed solid phase is called solid left. Example: Color Glass

Unlike homogeneous solutions, the second phase added to the liquid in colloids is insoluble, and there is a clear distinction between the two phases. The second phase can consist of nanoparticles and macromolecules. The dispersion phase dimensions vary from nanometer to micrometer [2].

What is sol?

The sol is the structure consisting of the liquid's continuous phase and the solid's dispersed phase. If the nano-sized solid particles are dispersed in the liquid phase and if they do not precipitate immediately, the structure is defined as the sol. It is possible to distribute the solid phase in a homogeneous manner by external forces such as centrifugation.

What is Gel?

The gel is a solid-like and wet structure in which the nanoparticles forming the solid network structure are placed in 3D. The continuous phase in a gel is the solid network formed by the nanoparticles, and the dispersed phase is the liquid phase. Gels have both solid and liquid properties. While their density is close to liquids, certain relationships exist between atoms, such as in solids.

Sol Production:

There are generally two methods of preparing the sol:

- Direct formation of nanoparticles in liquid: Molecules dissolved in the liquid are converted into larger molecules at the end of mixing liquids. The resulting macromolecules then become solid particles in nano-blocks. Example SiO_2 (silica) based nano-sol.
- Nanoparticles (such as carbon nanotubes and quantum points) are generated using specific production methods. The nanoparticles are then dissolved in the liquid phase. Surface modifiers (polymers, soaps, etc.) called surfactants ensure homogeneous distribution.

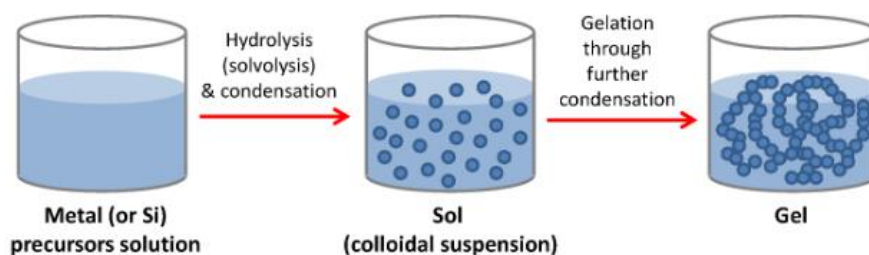
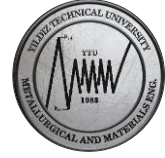

Figure 2. Schematic representation of the sol and the gel states [3].



Sol to Gel Transformation:

The solid nanoparticles dispersed in the solution must form a network structure to convert a solution to a gel. To form the network structure, the solid particles in the solution (called Brownian Motion in the liquid) must collide and stick together at the end of the collision. The bonding process is much easier for solid particles with reactive groups on their surface. Because after the collision, reactive groups can form a bond. Since adhesion will not occur for solid particles that do not have reactive groups on their surfaces, the surfaces of such nanoparticles must be reactive with additives or by peeling the surface. As a result, the non-reactive particles are brought together by the bond structure or electrostatic forces that will occur at the end of the collision.

As the solution turns into a gel, the viscosity of the structure increases, and the structure becomes non-flowable at the gel point. At the gelation point, the flow of the liquid has ended because the gel network formed by the particles is dispersed within the entire volume of the liquid. The time taken until the end of gel formation after the gelling agent is mixed into the sol is called the “gelling time”. [2].

Factors Affecting Sol-Gel Chemistry:

Sol-gel chemistry is affected by the following parameters.

- **pH:** pH is very important in colloid systems involving water. In the formation of silica gels, silanol groups are formed as a result of the hydrolysis of silica. The formation of silanol groups is affected by pH. The silanol groups then form the silica nanoparticles. Silanol groups then lead to the formation of silica nanoparticles and the development of the network.
- **Solvent liquid (solvent):** It is very important that the nanoparticles do not precipitate during the formation of the gel. Therefore, the solvent must be capable of dissolving the nanoparticles. In addition, the solvent also helps the liquid nanoparticles to form the network structure, thereby guaranteeing gelation.
- **Temperature:** The kinetics of the formation of the nanoparticles and the network structure formation is activated by the temperature. When the temperature is too low, the gelling time increases and causes too high agglomerates to over-grow and precipitate without forming the network structure.
- **Heat Formed by the Reaction:** The chemical reactions that occur during the formation of nanoparticles in the sol and the formation of the network structure cause heat release. This heat causes the reactions to accelerate.
- **Time:** Depending on the type of gel produced, gelation steps occur at different times. The product's properties resulting from the slower-formed solution are superior. The slower reaction results in a particularly uniform network in the gelation stage. This allows higher strength and more transparent (transparent) gels (if desired). The more transparent gel structure appears less bluish because it causes less Rayleigh scattering.
- **Catalyst:** In the sol-gel technique, acids (H⁺) and bases (OH⁻) are used as catalysts. The sol-gel method is sensitive to pH, as the catalytic effect is achieved through different mechanisms for acids and bases. Although the catalyst material is used in very small amounts (mg/mL), it reduces the gelation time from weeks to minutes.

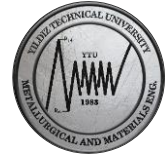

- **Mixing:** Mixing the sol in the sol-gel technique is important for the chemical reaction to occur uniformly. However, continued mixing after the gelation phase has begun may result in fragmentation of the semi-gelled web at micro and macro levels. Even if the gelation of the entire structure occurs at the end, the gelation time will be prolonged.

In sol-gel application, inorganic compounds such as metal alkoxide solutions or metal powders, nitrates, hydroxide, oxides, etc., are combined with a certain proportion of water and acid to form a solution. By mixing the solution at certain temperatures, a series of chemical reactions occur in succession in the solution. The electrochemical interactions of the particles form a network, and this process is called gelation. This network is growing and reaching all points in the system to create a complete structure of the gel is obtained.[1-5]

Steps of Sol-Gel Method

- Alkoxide hydrolysis
- Polymerization (Peptidization)
- Gel preparation
- Calcination and sintering

The first step in the sol-gel synthesis is solution formation. Various starting materials are mixed with the appropriate solvents in this step to prepare homogeneous solutions. The sol-gel process contains multiple steps, such as hydrolysis, polymerization, gelation, and calcination/sintering.

I. Alkoxide Hydrolysis

Alkoxides are used as starting material to form a solution. $M(OR)_n$.

- M; metal material to be coated,
- R; CH_3 (methyl), C_2H_5 (ethyl) alkyl group,
- n; shows the values of the metal that vary according to the value.

Due to their high electronegative OR group, metal alkoxides exhibit high reactive properties. Physical properties are controlled by changing the alkali groups in OR. The amount of water, catalyst type, solvent concentration, and temperature factors affect the rate of hydrolysis. Normally alkoxides are soluble in alcohol and hydrolyzed with water under acidic, basic, or neutral conditions. The optimum molar water/alkoxide ratio is 100. The distance between alkoxide and water molecules increases when this ratio is obtained. Acid catalysts bind polymers with weak bonds, while base (alkali) catalysts bind with strong bonds. When working in a hot environment with distilled water ($> 80\text{ }^\circ\text{C}$), a more stable colloid structure is formed [1, 5]. During hydrolysis, the OH-ion in the water replaces the OR-ion in alkoxide (Reaction 1).

Reaction1. Hydrolysis of alkoxide

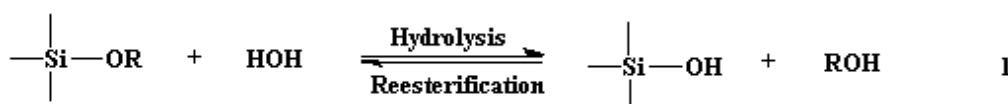

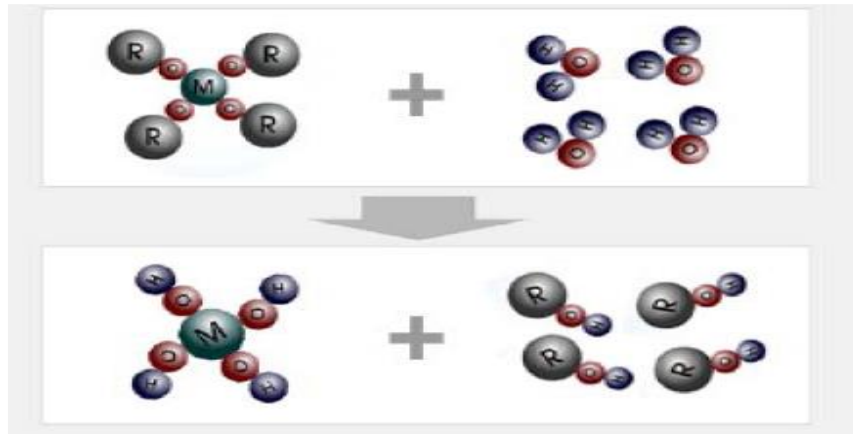
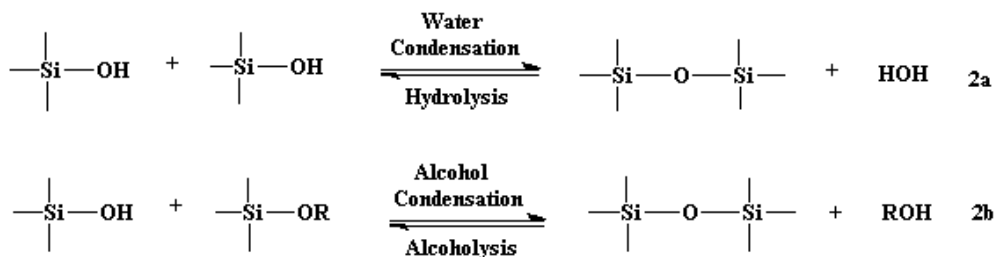

Figure 4. Alkoxide and hydrolyzed metal molecule

II. Polymerization (peptide):

The hydrolyzed Si-OH molecules during the polymerization step form Si-O-Si (siloxane monomer) bonds with two different reactions (Reactions 2a and 2b). This process is defined as asyon condensation. Condensation can occur in two ways: water condensation and alcohol condensation. In water condensation, water is released by converting Si-OH molecules to Si-O-Si molecules (Reaction 2a), while alcohol condensation produces alcohol (Reaction 2b). The polymeric oxide structure is formed by hydrolysis and condensation reactions. The polymers in the solution grow with a condensation reaction. This is the transition point from the solution to the gel and is determined by the increase in the viscosity of the solution.

Reaction 2. Condensation reactions



In the polymerization process, the solution is prepared by dispersing the precipitates through a solvent action. The electrolytes used in the polymerization give the particles a certain charge. The reason for the loading is that the colloidal particles are stable only when they are loaded. The amount of acid to be used is adjusted by the pH of the medium [6]. Polymerization is a de-coagulation event. Coagulation is the collapse of the colloidal particles due to the zeroing of the electric charge. If a solution forms a negatively charged colloidal solution, it forms a positively charged one with OH ions (bases) and is polymerized with H⁺ ions (acids). Peptidization does not occur if the electrolyte supplied to the solution is more or less than necessary. The high-concentration electrolyte prevents the peptidization by leaving the grains unloaded. When it is used in small amounts, the sediment condition continues as the load is insufficient [5-6]. The selected acid type is one of the important factors affecting peptidization. When the acid concentration is too low, the effect of the electric charge cannot be achieved.

This condition makes it impossible to use almost all other organic acids in the solution gel process except for a few strong acids.

III. Gelation:

The monomers formed by the polymerization in the solution come together to form the nanoparticles [6]. The gelation event is closely related to the shape of the colloidal particles. The gel-forming molecules bind to each other with weak or strong bonds, forming skeletal tissues with liquid in the spaces between them. These tissues form the gel structure. The gel formation constitutes sufficient small sol particles for the prepared solution. These particles are formed by agglomerates (agglomerates) with the electrochemical interaction of the surface charges or by forming gels of precipitated solid particles (Figure 5). The gels in this web structure are then spread over the entire structure and expand triple in volume.

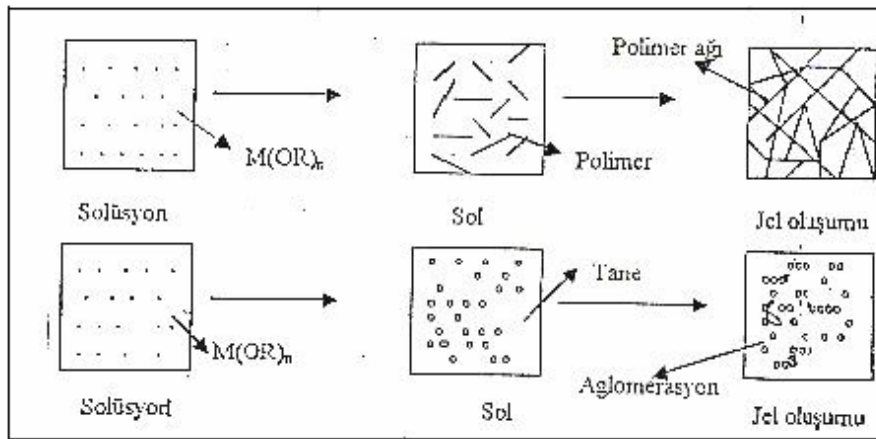

Figure 5. Polymerization Process

IV. Calcination and Sintering

After drying, the gel is heat treated for the production of dense ceramic material. According to the structure of the gel and the conditions of formation, the following reactions occur during the heat treatment;

- Decomposition of salts,
- Carbonization or organic waste combustion,
- Chemical water removal,
- Loss of micropores,
- condensation

The gelling material is usually calcined by heating it to a temperature lower than its melting temperature. At the end of the process, the porosity of the material decreases. With calcination and sintering, the mechanical properties of the material also increase.

Advantages and Disadvantages of the Sol-Gel Method

Advantages of the Sol-Gel method [3];

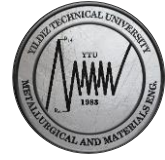

- Synthesis of solids with high surface area and free energy at a lower temperature is ensured.
- Fiber production is provided using metal-alkoxide solutions (SiO_2 , $\text{ZrO}_2\text{-SiO}_2$, $\text{Na}_2\text{OZr-SiO}_2$).
- It allows the production of solid glass materials which cannot be obtained by cooling from the liquid phase (CaO-SiO_2 , SrO-SiO_2 , $\text{SiO}_2\text{-TiO}_2$, $\text{SiO}_2\text{-Al}_2\text{O}_3$).
- It allows the production of thin SiO_2 and TiO_2 ($\leq 1\mu$) coatings on glass. Improvement of chemical, electrical and optical properties of coated surfaces is provided by the sol-gel method.
- Controllable shapes and sizes of dust are produced.
- Homogeneous distribution of the second phases in the main phase (0.3% $\text{TiO}_2\text{-SnO}_2$)

Disadvantages [3];

- The cost of produced powders is high.
- The process is long, and the amount of shrinkage during the process is high.
- Fine pores may be in structure.
- Residual hydroxide in the structure, residual carbon can be formed.

3. EXPERIMENTAL STUDIES

3.1 Tools, Devices, and Materials

- Tetra Ethyl Ortho Silicate (TEOS, $\text{Si}(\text{OC}_2\text{H}_5)_4$)
- Ammonium Fluoride (NH_4F)
- Ammonium Hydroxide (ammonia, NH_4OH)
- Ethanol ($\text{C}_2\text{H}_5\text{OH}$)
- Pure water
- Fume hood
- Precision scales
- Magnetic stirrer
- Magnetic fish
- Pipette pump, pipette, and dropper
- Beakers
- Materials for underlaying
- Turntable
- Power source
- Furnace

3.2 Experimental Procedure

For the experiment, firstly, sol production is performed. In the preparation of the sol, 3 mL of TEOS and 5 mL of ethanol (in a fume hood) are mixed in a beaker using a magnetic stirrer (Solution I). (Since the silicon-based alkoxide TEOS can hydrolyze in the lungs if inhaled, it is recommended to mix it under air flow.) Then, 3 mL of water is dissolved in 5 mL of ethanol



(Solution II). A solution consisting of two different catalysts (Stock Solution) is used to form the sol. To prepare the stock solution, 1.9 g of ammonium fluoride salt (NH_4F) and 23 mL of ammonium hydroxide (NH_4OH) solution are dissolved in 100 mL of distilled water. Add 10 drops of the stock solution to Solution 2. Finally, the second Solution is slowly added to Solution 1, which continues to mix. During the addition of Solution 2, the transparent Solution 1 gradually becomes whitish and opaque. This is due to the polymerization of the left molecule growing as a result of the formation of nanoparticles. After the polymerization process, the structure appears as opaque (milky) as some of the light held in the solution is reflected by the nanoparticles (Tyndall Effect). The SiO_2 (silica) source used in the preparation of the sol provides TEOS water loss, while ethanol is the solvent that helps TEOS and water mix. During the hydrolysis reaction, base (alkali) based ammonium hydroxide (NH_4OH) acts as a catalyst, accelerating the formation of Si-OH bonds. Although hydrolysis takes place if the ammonium fluoride salt is not used, the reaction rate is further increased with the fluoride ion present in the ammonium fluoride. As the amount of polymerization increases, the viscosity of the solution increases. Before gelation, spin coating process is performed on the substrates on the turntable by taking them from the left with a dropper, or dip coating process is performed by immersing and pulling the substrate into the left.

Dipping Coating:

The dip coating method is carried out by dipping a substrate material into a solution for coating and withdrawing it at a constant speed, controlled temperature, and atmospheric conditions.

Coating thickness depends on the following parameters;

- Substrate retraction speed
- Surface tension of the substrate
- Depends on the density and viscosity of the solution.

The steps of the coating by dipping method;

1. Dipping the substrate into the solution
2. Removing the substrate from the solution
3. Evaporation of the solvent from the solution on the surface of the substrate

Spin Coating:

Spin Coating is used in the production of thin films. Typically, the process is based on dropping a drop of solution into the center of a pad and then rotating the pad at high rotational speeds (typically 3000 rpm). Central acceleration causes the excess solution to be removed and the remaining solution to spread as a thin film on the substrate surface.

Final film thickness and coating quality depends on the following parameters

Solution properties such as;

- viscosity,
- drying rate,
- solid rate and
- surface tensions

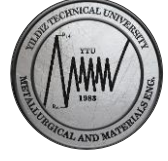

Process conditions such as;

- speed,
- acceleration etc. Typically, the coating process consists of three steps.
 1. Dropping solution on the prepared substrate
 2. With high-speed rotation, the removal and spread of excess solvent and
 3. With drying, the solvent is evaporated and the coating process is completed with gelling.

Powder Production via sol-gel technique:

Finally, the sol-gel poured into the mold is completely gelled at the end of 15 minutes. Drying of the gel (removal of water or alcohol as a by-product) and calcination produce nano-spheric SiO₂ powder. At the end of the calcination process, the powder obtained from the oven is ground in a mortar, and the final powder product is obtained.

4. RESULTS AND DISCUSSION

Weigh the gel product before drying and calcination. Re-weigh after drying and calcination. Thus, the weight loss in the sample is calculated as %.

At the end of the experiment, gel production should be ensured starting from the sol. Then, oxide-based nanopowder should be obtained by drying and calcining the obtained gel. SiO₂ film should be formed on the substrates by using dip coating and spin coating techniques of the prepared sol. During coating, the effective parameters (solution viscosity, coating speed, etc.) for both methods should be changed, and the effect of these parameters on the coating quality should be observed. At the end of the experiment, students will have learned the following practical and theoretical outcomes:

1. Colloidal systems
2. Basic principles of the sol-gel technique
3. The Sol-Gel coatings
4. Characterization of coating layers
5. Nanopowder synthesis with sol-gel technique
6. Preparation of the final report (theoretical knowledge, experimental study, results, references)

5. REFERENCES

1. İnternet kaynağı: URL: <http://www.aerogel.org>
2. İnternet kaynağı: URL: <http://www.psrc.usm.edu/mauritz/solgel.html>
- 3.Yrd.Doc. Dr. Atilla EVCİN, Sol Jel Prosesleri Ders Notları, www2.aku.edu.tr/~evcin/
4. James S. REED, Principles of Ceramics Processing, 2nd edition. 1995. Wiley Publishing, ISBN 978-0-471-59721-6



2022-2023 Spring MSE3952 Laboratory II
Experiment 3: The Sol-Gel Technique

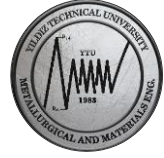

5. Pierro Alain C., 1998, Introduction to Sol Gel Processing. Springer Publishing, ISBN-978-0-7923-8121-1

6. John. D. Wright, Nico A. J. M. Sommerdijk, Sol Gel Materials Chemistry and Applications. Taylor and Francis Group, ISBN 978-90-5699-3269

EXPERIMENT 4: RECYCLING

1. OBJECTIVE OF THE EXPERIMENT

The objective of this experiment is to inform the students about secondary aluminum production processes from the scrap.

2. THEORETICAL INFORMATION

2.1. FUNDAMENTAL DEFINITIONS

Waste: Materials and items that need to be disposed or already disposed.

Reuse: Repeatedly using of wastes until they reach the end of their economic lifetime, without any treatment other than collecting and cleaning.

Recycling: Operation of bringing materials back to manufacturing processes as a raw material after their lifetime has ended.

Recovery: Physical, chemical or biochemical methods to transform the components of the waste into other products or different forms of energy depending on the characteristics of the waste. Definition of recovery also includes both reuse and recycling phenomena.

Recycling Rate: Ratio of the total amount waste recycled to the total amount of waste generated.

The main scraps used for the aluminum recycling are;

- Beverage cans,
- Aluminum foil wastes, cake pans, and some other kitchenware,
- Plates,
- Window profiles made of aluminum,
- Outdoor and patio furniture,
- Cables,
- Aviation scraps,
- Automotive scraps,
- Extrusion, casting and machining processes sourced scraps.



Figure 1. Images of some aluminum scraps

At the first step, soiled and used aluminum pieces which may be painted or coated are delivered to the conveyor with other packaging wastes. Throughout the conveyor, waste pile is passed through some large magnets in order to remove iron-based and some other metals. Separated aluminum wastes are crushed and baled via scrap baling machine thereafter to be delivered to

production facility. Main reason of baling is minimizing the logistic expenses. Baled aluminum may contain excessive moisture which may cause burst in furnace at high temperatures. In order to prevent this incident bales are crushed first. Afterward, crushed pieces are placed into hot furnace for removal of present paint, moisture and other pollutions at working temperature. After removal stage, aluminum is molten for forming processes at 700 °C in a rotary furnace with accompanying stirring to attain complete melting. Process gases need to be removed with powerful fans then to be cooled and treated in industrial filter bags for removal of residual particles before releasing to atmosphere through high chimneys. Molten aluminum accumulated at the bottom of the furnace is collected to cast into desired moulds. After several steps they can be used for diverse applications again.

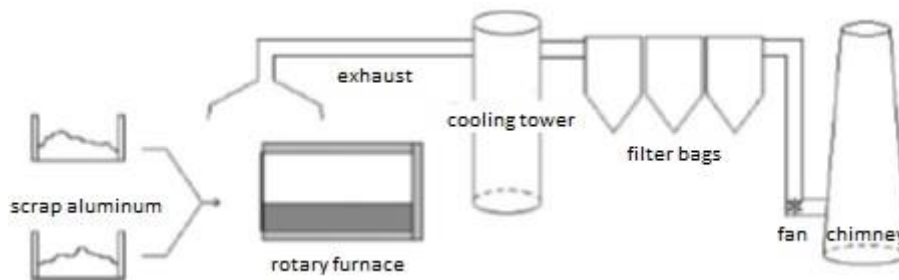

Figure 2. Image of aluminum recycling unit

Recycling of used aluminum not only creates more space for wastes, it also reduces the consumption of bauxite ore and energy.

When one ton of aluminum is produced from used aluminum;

- 1.300 kg bauxite,
- 15.000 liter cooling water,
- and 860 liter process water are consumed less.
- 2.000 kg CO₂ and 11 kg SO₂ are less emitted.

Required energy for producing aluminum from scrap is less almost twenty times than required for producing from bauxite ore. Also it reduces the emission of pollutant gases by %99, greenhouse gas emission by %95 and waste water pollution by %97 rate so recycling contributes energy-saving furthermore it is environment friendly.

2.2. IRON AND STEEL RECYCLING

Iron is third most abundant metal in the Earth's crust. The metal iron can be obtained from iron ores and it rarely exists as the element iron. Haematite, limonite, goethite, magnetite, siderite and pyrite can be listed as the well-known iron ores. To obtain metallic iron, the impurities in the ore must be removed by chemical reduction and it is mainly used in steel making which can be regarded as a carbon alloy. When iron is heated with carbon to a temperature of 1150-1200 ° C, the resulting melt is an alloy containing 96.5% Fe - 3.5% C and called cast iron or pig iron. This product can be cast in fine details, although it remains extremely fragile to be formed as long as it is not decarburized to remove the most of contained carbon.

Classification of steel scraps by source:

- Circulating scrap; scraps that are acquired from units like steelworks, foundry and rolling plants with well-known chemical analysis and high quality.

- Old Scrap; especially automobile bodies sourced scraps which containing slight amount of phosphorus and sulfur.

For iron and steel recycling, foreign substances in the scrap which have lower oxygen affinity than iron like copper and tin should be taken care of during the process.



Figure 3. Images of iron and steel scraps

Recycling in iron and steel industry is mainly carried out in electric arc furnaces which is a good option for iron and steel making. Unlike the basic oxygen steelmaking method, cold metal (scrap) is used in electric arc furnaces instead of hot metal. The scrap steel is poured into an electric arc furnace with a crane from the top and furnace is closed with a cover subsequently. This cover carries three electrodes those dip into the furnace. The electricity passing through the electrodes creates an arc, and the heat that comes out melts the scrap. The amount of electricity used in this process is high enough to meet the energy needs of a city with 100,000 people. Other metal alloys can be added to obtain the required chemical composition in the smelting process. The oxygen is also blown to purify the desired steel iron.



Figure 4. Image of operating electric arc furnace

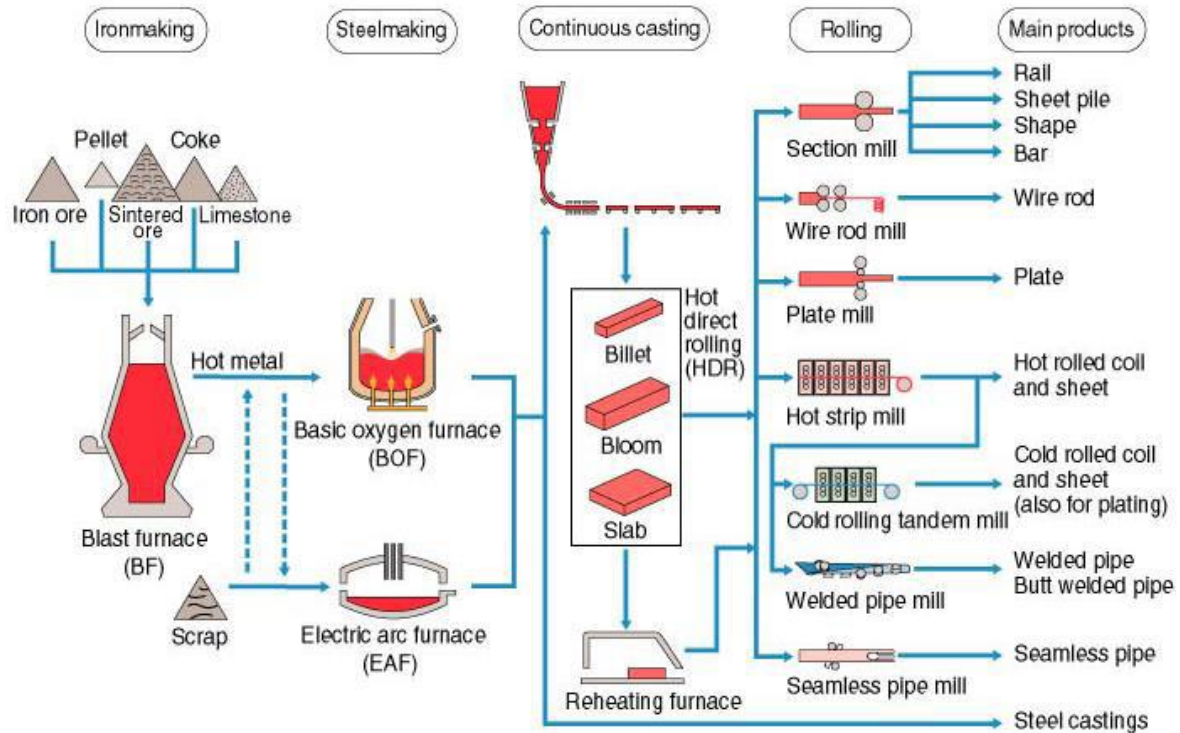

Figure 5. General flow scheme of iron and steel making

2.3. RECYCLING OF COPPER

Following scraps are generally used for secondary copper production;

- Wire rods
- Heat exchangers
- Copper tubes
- Cables and electrical connectors
- Electromotors, generators, transformer coils
- Miscellaneous copper plates and sheets.



Figure 6. Images of copper scraps

Copper production from scrap is usually made in two ways;

1. Melting at a copper smelter along with copper ore
2. Melting along with a proportion of copper ingots at a dedicated copper recycling plant

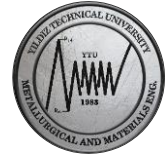

At a copper smelter, the scrap copper and alloy components are loaded into the furnace which is then fired up. The copper ore is fed into the furnace along with the required amount of limestone and sand. Oxygen and air are supplied and when the mix has become molten, it is then tapped into rectangular molds. The resultant rectangular plates are then purified to 99.9% pure copper using electrolysis processing.

At a copper recycling plant, the bales of compacted copper along with the required content of alloys are loaded into a furnace along with a proportion of pure copper ingots.

The furnace can either be of an electric induction type or a reverberatory one. The electric furnace melts all the contents and tips to pour the molten copper through a spout into molds for either further processing or they are shipped to a copper smelter.

A reverberatory furnace is a square box structure lined with firebricks and is usually gas fired, having a loading door at the front which can be lowered or raised as required. Once the copper is molten, samples are taken, and when approved, the molten copper is poured into molds and left to cool. The resultant copper ingots can be sent for further refining or dispatched to a copper smelter for further processing.

- The cost of copper from scrap is lower than from ore. The recycling of 1 ton of copper from the waste/scrap saves 85% of the total energy consuming comparing to primary production.
- Considering that 12-13% of the reserves are used in the world, it seems that their life span is limited, via recycling the existence of raw material resources is extended.
- The storage and removal of municipal solid waste are highly expensive processes. With recycling operations this expenses can be lowered and those waste product can be reused as raw materials.
- Recycling is more environment friendly process due to less gas and dust releasing during the whole steps.

3. EQUIPMENT AND MATERIALS

Materials:

- Aluminum scrap
- Thick scrap (Excessive parts of cast products)
- Fine scrap (Chips from machining process)

- Flux (composition will be given during the experiment.)

Devices/Equipment

- Melting crucible
- Melting furnace
- hydraulic press
- Cylindrical steel mould
- Oven
- Precision scale
- Mould for casting

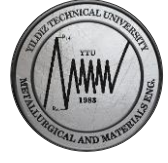

4. EXPERIMENTAL PROCEDURE

On the first step, thick scrap at the half of the total charge is weighed and placed in the furnace with melting crucible at 730 °C for melting. Liquid metal forms in the crucible at the end of this process. During the melting of thick scrap, fine scrap chips are briquetted using a hydraulic press in a cylindrical steel mold. At this step, compressive pressure of the press and fill factor of the briquettes will be measured. Total amount of the briquettes should constitute other half of the total charge, so fine and thick chip ratio will be % 50 – 50. Before being placed in the melting crucible, briquettes are preheated for some time. Preheating time and temperature will be determined during the experiment. Subsequently, the briquettes are added to the liquid metal pool in the crucible. During the melting process of the briquettes, the powdered chemicals that will form the flux are weighed on a precision scale and mixed in a container. The mixture is added into the crucible and mixed in liquid metal with a metal rod. After standing in a furnace for about ten minutes, liquid aluminum is cast into a metal mould and solidified. On the last step cast metal will be weighed to calculate total melt and recycling efficiency.

5. ASSIGNMENTS AND REQUESTS

Whole necessary calculations will be made by students and further assignments will be given during the experiment.

6. REFERENCES

- 1)<http://www.kimyaevi.org/TR/Genel/BelgeGoster.aspx?F6E10F8892433CFF8007620E7D5602E8B856E08843ECBADB> (Erişim Tarihi : 10.09.2017)
- 2)http://celik.org.tr/wp-content/uploads/2016/12/4-TCUD-Curuf_Rapor.pdf (Erişim Tarihi: 10.09.2017)
- 3)<http://www.brighthub.com/environment/green-living/articles/66929.aspx> (Erişim Tarihi: 10.09.2017)

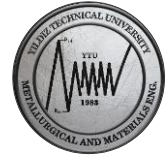

EXPERIMENT 5: BIOCERAMIC SCAFFOLD PRODUCTION

1. PURPOSE OF THE EXPERIMENT

The aim of this experiment is to learn the production of 3-dimensional ceramic-based tissue scaffolds for use in ceramic materials and hard tissue applications.

2. THEORETICAL INFORMATION

Tissues in the human body have the ability to regenerate themselves thanks to a certain cycle of construction and destruction. However, this cycle may be disrupted due to reasons such as age factor, trauma, and disease. When remodeling system breaks down, the bone tissue cannot repair itself and thus loses its functions.

There are various methods that can be used to support bone regeneration and restore bone restoring properties, in situations that decrease quality of life. One of them is the use of "tissue scaffolds". The purpose of this application is to restore bone loss by remodelling lost bone tissue. In these applications, biocompatible synthetic or natural materials are used.

2.1 BONE STRUCTURE

Bone is a well-organized natural composite structure from macro level to nano level (Figure 1). The main component of the organic part of the bone is collagen (polymer) and the main component of the inorganic part is the hydroxyapatite (ceramic) mineral. The two most important bone types are cortical and cancellous bone. Cortical bone (Figure 2) is a dense structure with high mechanical strength and is also known as compact bone. Spongy or trabecular bone (Figure 2) is a porous structure located at the ends of long bones such as femur or short bones within the boundaries of the cortical bone [1].

Cortical bone forms the hard, stiff and dense cortex layer that supports the whole body. It has an outer layer called the "Periosteum" and an inner layer called the "Endosteum". The Osteon/Havers system is the functional unit of the cortical bone. It consists of haversian canals the center surrounding the blood vessels and the haversian canal is surrounded by coaxial lamella layers. The bone matrix (thin layers called lamellae, 3-7 μm width) is formed by bone-forming cells called osteoblasts. Osteoblasts are formed by the differentiation of the mesenchyme stem cells (MSC) of the bone marrow. The remodeling process is initiated by osteoclasts responsible for the absorption of the bone matrix [2].

2.2 BONE REPAIRING BIOMATERIALS

Bone plays an important role in the homeostasis (balancing) of minerals. The most important of these minerals, phosphate and calcium ions are stored in the bone and can be released into the blood when necessary. Another important function of bones is movement, load bearing and protection of the internal organs of the body. Bone tissue is a dynamic and highly vascularized tissue. Most fractures do not require any surgical intervention. However, surgical operation is required for large bone defects and non-union fractures. The high regenerative feature of bone is a process that continues throughout the life of the individual. Treatment of damaged tissues can be carried out using an autograft or an allograft. Autografts, which are accepted as the gold standard, are structures that are taken from the person and implanted into the damaged tissue. The bone graft taken from the person itself integrates into the body faster and reduces the risk of contamination. On the other hand; Autografts have several disadvantages due to blood loss, longer surgical time, infection and limited amount of graft material.

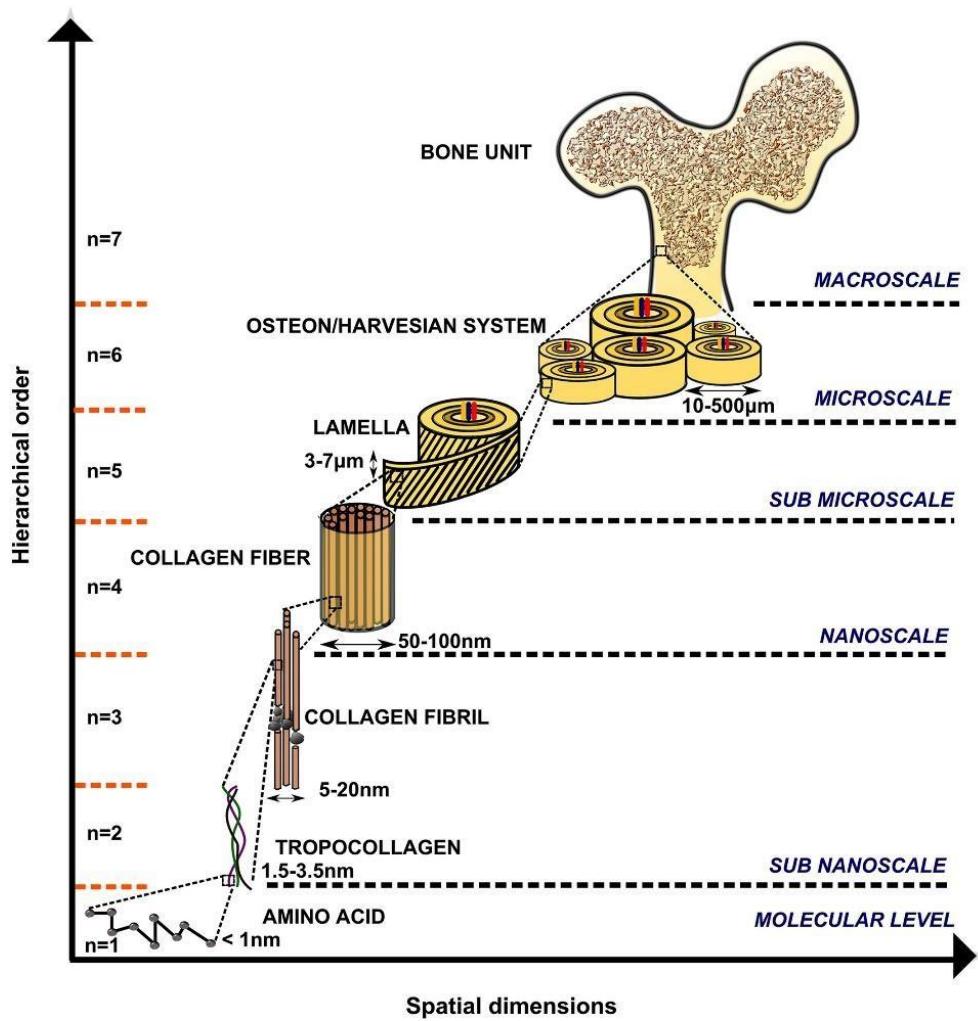

Figure 1 Hierarchical arrangement of bone in various length sizes [2]

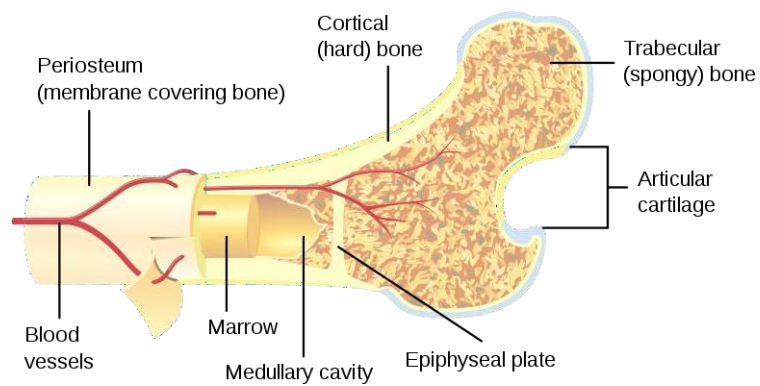

Figure 2 Cross section of bone [3]



Allogenic bone grafts are structures that are implanted from another person. These structures should provide osteoinductivity and osseointegration. Osteoinductivity means that the bone can grow. In osteoinductive grafts, spongy bone formation occurs towards the graft surface, pores, channels or pipes. Osseointegration is about the attachment between bone and implant. Appropriate placement of a graft is affected by many factors, such as the type of graft and the site of placement.

There are also various synthetic grafts developed in place of biological grafts. In the past, researchers was focused on the development of bioinert materials, while today they focuses on the development of bioactive materials that can bond with biological molecules. Materials that can be used in place of autologous and allogenic grafts can be listed as bioactive ceramics, bioactive glasses, biological or synthetic polymers and composites. In these materials, it is easier to avoid transplant problems such as infection or poor compliance with environmental stresses. The ideal material is expected to be completely replaced by biological tissue.

The term tissue scaffold is used for three-dimensional (3D) biomaterials, which provide a favorable environment for cells to regenerate tissues and organs. The purpose of the production of tissue scaffolds is to ensure that regenerative signals are sent to the cells to naturally simulate the tissue healing. The most important phenomenon in tissue scaffolds are their 3D structures. Interconnected pores and high porosity allow 3D tissue regeneration, cell growth, cell proliferation and differentiation, and the diffusion of waste and decomposition products. The pore size should be large enough to allow cells to move, but small enough to allow cells to attach to the scaffold. Decomposition of the scaffold should take as long as tissue regeneration. Therefore, an ideal scaffold for bone tissue should be osteoconductive, biodegradable and have appropriate mechanical properties.

2.1.1 Types of Materials

Historically, the main feature expected from first-generation biomaterials is biocompatibility, while the feature expected from second-generation biomaterials is bio-interaction. Third generation biomaterials are expected to be bio-reactive, for example, they should activate genes, proliferation and differentiation of cells. Today, the most commonly used materials for bone tissue scaffold production are inorganic materials and natural or synthetic polymers.

Polysaccharides (such as starch, alginate, chitin/chitosan, hyaluronic acid derivatives) or proteins (such as soy, collagen, fibrin gels, silk) help cell adhesion and function. However, immunogenicity may occur due to pathogenic impurities, moreover controlling of the mechanical properties and biodegradation may be more difficult.

Synthetic polymers such as poly (lactic acid) (PLA) and poly (glycolic acid) (PGA) and their copolymers are widely used because of their superior mechanical properties and decomposition rates in cell transplantation and in scaffolds for tissue engineering.

Metals can be considered as the oldest type of material used in implant production. The first metals used in biomaterial applications were aluminum, lead, gold and silver. Today, titanium and its alloys are the most commonly used metallic biomaterials for dental and orthopedic implants due to their high biocompatibility, low toxicity and high corrosion resistance.

Inorganic materials such as metals, bioactive glasses, tricalcium phosphate (TCP), hydroxyapatite (HA) and their combinations are other groups of materials used in bone tissue engineering due to their similarity to the bone mineral phase. There are also biphasic ceramic structures such as HA-TCP and wollastonite developed from these materials. Bioceramics are

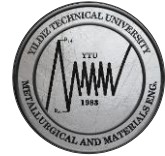

biomaterials used not only in bone tissue engineering, but also in orthopedics and dentistry. The most widely used bioceramics in bone tissue engineering are HA, TCP and their composites [4].

2.3 SCAFFOLD PRODUCTION TECHNIQUES

2.3.1 Conventional Production Methods

Conventional methods for fabricating porous tissue scaffolds mainly include methods such as solvent casting/particulate leaching method, microsphere sintering, gas foaming process, sponge (replica) method, melt molding method, phase separation method, fiber bonding method and electrospinning.

2.3.1.1 Solvent Casting and Particulate Leaching

Solvent casting/particulate leaching method is the most used method in tissue scaffold production. In this method water-soluble particles are added to the polymer solution, and the mixture is cast into the desired shape. After the solvent is removed (evaporated or lyophilized), the resulting structure is treated with water to remove porogen particles, and then porous structure is obtained. In addition to salt and sugar, lipids are also used as porogen particles. When using this method, the pore size and porosity of the tissue scaffold can be controlled by adjusting the added porogen size and the particle / polymer ratio. However, the shape of the pores is limited to the shape of the porogen. The most important advantage of the method is the use of a small amount of polymer. Although it is easy to apply, it is not possible to obtain thin membranes and very fine 3-dimensional porous structures in the thick structures since it is difficult to remove the particles with water. The high amount of solvents, some of which may be toxic, and the presence of residues of these solvents in the structures can prevent cell adhesion and proliferation [5].

2.3.1.2 Gas Foaming

Porous ceramic scaffolds can also be produced using the gas foaming technique. Ceramic sludge can be foamed by the following methods;

- Passing air bubbles through the mud,
- Sweeping air into the mud using high speed rotary blades,

Stabilizing agents such as agar or polymeric materials are used to keep the sludge stable. Porous tissue scaffolds can also be obtained by pouring and drying the ceramic slurry and then burning the drying structure. In sintering, stabilizing organic agents leave a porous ceramic structure and move away from the structure. With this method, it is possible to manufacture ceramics with pores connected with each other [6].

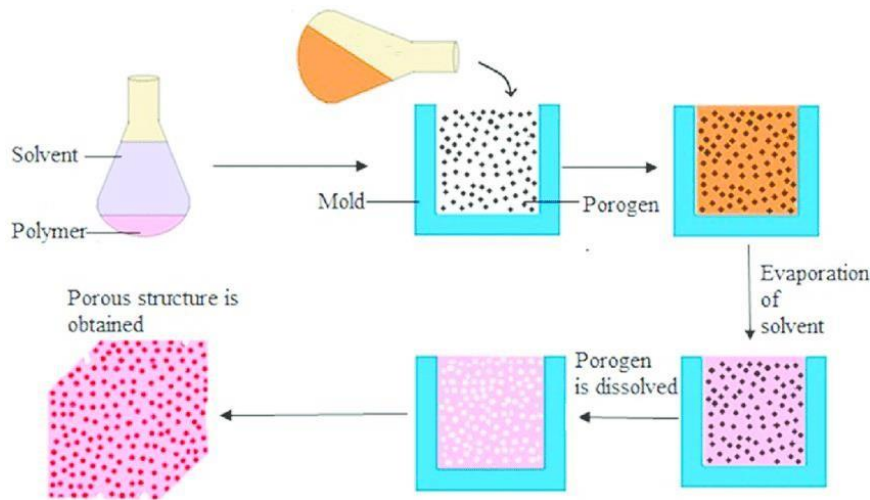

Figure 3 Schematic representation of the solvent casting /particulate leaching method [7]

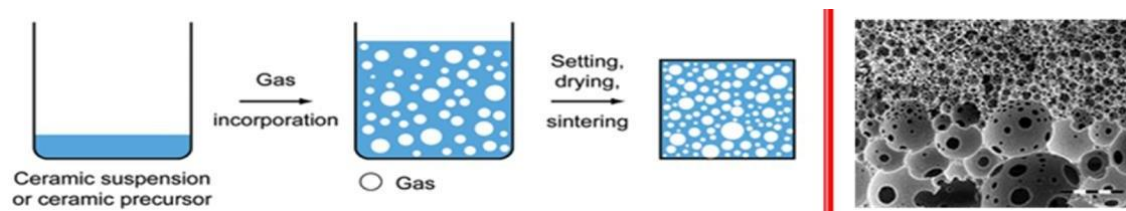

Figure 4 Schematic illustration of the gas foaming method [8]

2.3.1.3 Replica (Sponge) Method

Polymeric foam substrates can also be used to produce porous ceramic materials. The ceramic mud is either absorbed into the foam or covered with foam ceramic slurry and allowed to dry before burning. During the sintering process the polymeric particles burn and ceramic is sintered to crystalline structure which is contained interconnected pores.

Ceramic density and pore size, shape and distribution depend on the method used. Open porous structures with up to 70% porosity can be produced by taking a positive view of the foam. In this method, the mud is coated on the foam strips and during the combustion, the foam is made open porous and burns. The positive image of the porous foam is given in Figure 5 (a). Alternatively, the foam can be absorbed completely with ceramic slurry so that all voids are filled. A negative image of the foam is obtained during combustion as shown in Figure 5 (b). In this way, the material will have approximately 5-10% porosity.

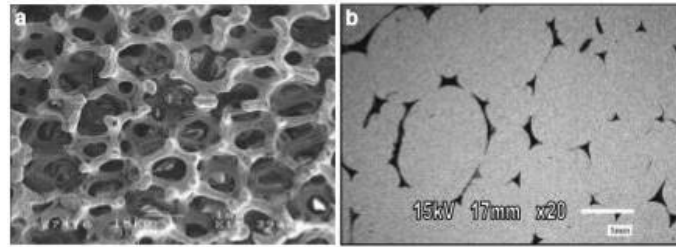

Figure 5 (a) Open porous HA structure (b) Dense HA ceramic structure with interconnected porosity [6]

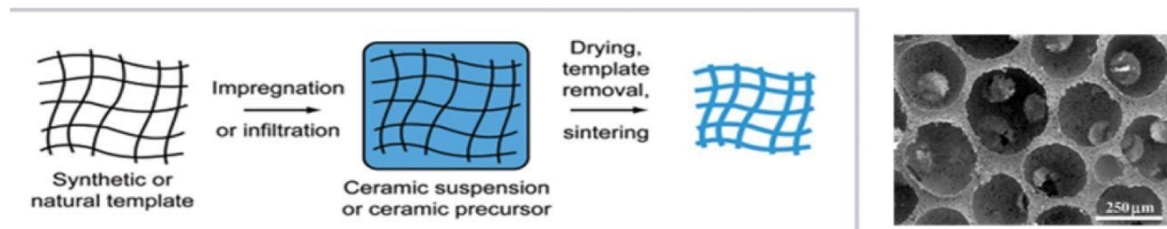

Figure 6 Schematic representation of the replica method [8]

2.3.1.4 Phase Separation Method

In this method, multicomponent systems such as polymer-water emulsions are used. These systems can become thermodynamically unstable at certain temperatures and phase separation occurs when the free energy decreases. First, two polymer-rich and polymer-poor phases are formed. Then, by removing the solvent (by lyophilisation or solvent extraction), the polymer-rich phase solidifies and the porous structure is obtained. Phase separation can be done in two ways: thermal separation (TIPS) and solvent and phase separation (SIPS). In the more commonly used SIPS method, the polymer solution is placed in a container and placed in a bath where the polymer is insoluble but has a second solvent that can form a solution with the polymer solvent. Phase separation occurs by contact of solvents. The structure of the tissue scaffold can be controlled by adjusting the phase separation conditions. The phase separation method can be in the form of solid-liquid phase separation and liquid-liquid phase separation. In the solid-liquid phase separation method, by lowering the temperature of the polymer solution, the solvent crystallizes, and by separating the solvent crystals (sublimation or solvent exchange) pores are formed in the regions where the solvent crystals are separated. In the liquid-liquid phase separation method, polymer-rich and polymer-poor phases are separated by bringing the polymer solution to a temperature above the critical solution temperature. Open porous structures are formed by separating the solvent. Phase separation method is also used in the preparation of internally linked nanostructures. Phase separation is a simple method, but there are disadvantages such as limited solvent combinations, requiring additional steps for washing, and solvent residues in the prepared structure [5]. Compared with the solvent casting/particle separation method, it is possible to obtain structures with a lower pore diameter and higher pore area by freeze drying method. The formation of closed pores in structures

prepared using this method is the most important disadvantage of the method.

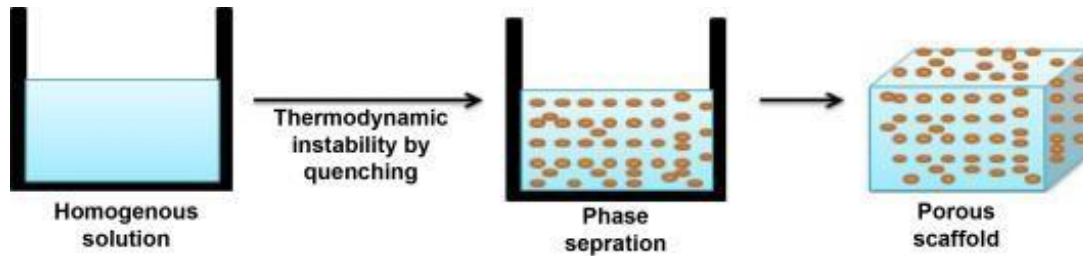

Figure 7 Schematic representation of the phase separation and lyophilization method [9]

2.3.1.5 Fiber Bonding

Fiber bonding method is one of the oldest tissue scaffolding production methods and developed for the purpose of using biodegradable polyglycolic acid (PGA) surgical threads as tissue scaffolds. Briefly, a solution of poly-L-lactic acid (PLLA) dissolved in a solvent that does not dissolve PGA is added to the network prepared from PGA. After removing the solvent, the PLLA-PGA composite structure is heated to above the melting temperature of the PGA. Thus, the PGA strands that are in contact with each other melt and physically merge. The PLLA in the structure is again removed by using solvent. Following the drying process, a tissue scaffold consisting of PGA, with structural integrity is obtained [5].

2.3.1.6 Electrospinning

The electrospinning method is based on the principle of obtaining polymers in fiber structure using electrostatic forces. In this method, high voltage is applied to the polymer solution in a capillary feeding unit. When the formed electrostatic forces overcome the surface tension of the polymer solution, the flow formed in the form of a fiber jet is collected in an unstable structure in a fiber form on a conductive plate or roller acting as a collector. Electrospinning method is important in tissue engineering applications since it can be applied to many polymers. By using the electrospinning method, it is possible to obtain non-knitted mesh or linear structure fibers from nanometer sizes to micron sizes under different process conditions. Many parameters affect the properties of the product to be obtained, such as the properties of the polymer and the type of solvent, the flow rate of the solution, the applied voltage, the distance of the needle from the collector, and the polymer concentration. In the structures obtained by this method, fiber size is the most important factor as it affects the pore size and porosity of the scaffold. However, it is not a suitable method for obtaining three-dimensional structures, since only thin membranes can be prepared by the electrospinning method [5].

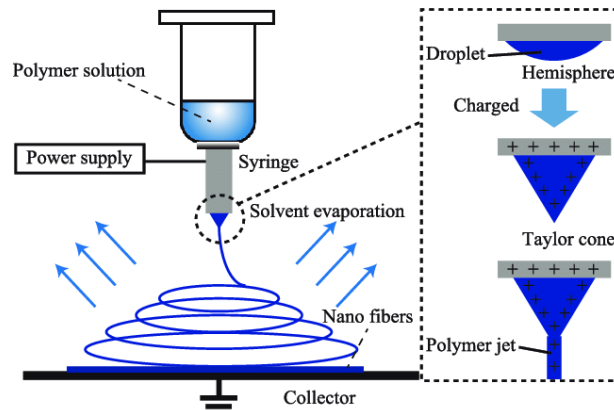

Figure 8 Schematic representation of the electrospinning method [10]

2.3.1.7 Melt Molding

The melt molding method was developed to overcome restrictions in the solvent casting/particulate leaching method. In this method, the polymer is heated to temperatures above the glass transition temperature, the particles that will act as porogen are mixed and pressed under constant pressure. Washing with water is carried out to remove particles from the mold. Thus, a porous structure is formed. In this method, organic solvents are not used and tissue scaffolds can be produced as desired by changing the mold. However, the melt molding method can only be applied to thermoplastic polymers [5].

2.3.2 Rapid Prototyping

Rapid prototyping methods are tissue scaffold manufacturing methods based on advanced computer technology. 3D printing, stereolithography (SLA), fused deposition method (FDM) and selective laser sintering (SLS) methods are rapid prototyping methods. In these methods, the design of complex shaped structures is formed using software such as computer aided design (CAD), computed tomography (CT) and magnetic resonance imaging (MRI). The prepared digital information is converted into special section format as layer series for the device. Tissue scaffolding is produced by spreading binders between polymer layers processed using original devices [5]. These methods are successfully applied for scaffold production with controlled pore structure and shape [1].

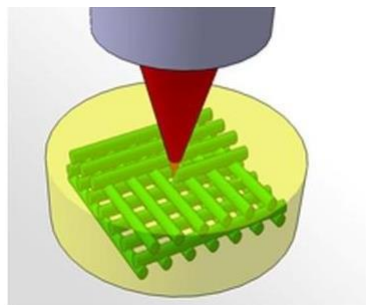
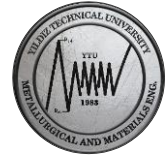

Figure 9 Schematic representation of scaffold production with FDM [11]



3 EXPERIMENTAL STUDIES

3.1 Tools, Devices and Materials

- Glass and Other Materials: Beaker, Glass Stirring Rod, Spatula, Graduated Cylinder, Sample Weighing Container, Burette, Filtering Flask, Filter paper
- Devices: Magnetic Stirrer, pH Meter, Analytical Balance, Oven, Sintering Furnace
- Chemicals: $\text{Ca}(\text{NO}_3)_2 \cdot 4\text{H}_2\text{O}$, $(\text{NH}_4)_2\text{HPO}_4$, HCl, NH_4OH , Porogen (Starch), Binder (Triethyl phosphate), Distilled water

3.2 Sample Preparation

3.3 Synthesis Of Hydroxyapatite Ceramics

In the first step of the bone scaffold production hydroxyapatite will be synthesized.



- 1M calcium nitrate tetrahydrate [$\text{Ca}(\text{NO}_3)_2 \cdot 4\text{H}_2\text{O}$] and 1.2M diammonium hydrogen phosphate [$(\text{NH}_4)_2\text{HPO}_4$] are dissolved separately in 1L and 0.5L distilled water, respectively.
- The Ca-containing solution is added to the P-containing solution with an addition rate of 4 m/min.
- The pH of the solution is adjusted to 9 with ammonia [NH_4OH].
- The solution is mixed for 1h and then aged at 37 °C for 24h.
- Aged ceramic sludge is filtered with blue band filter paper and washed with distilled water.
- Sludge dried at 80 °C and then sintered at 900 °C for 1 h and finally ground in agat mortar.

3.4 Preparation Of Ceramic Slurry

- A suspension is prepared by mixing 11 g of the grounded hydroxyapatite ceramics with 25 mL of distilled water.
- In a separate place, 6 mL of triethyl phosphate and 0.4 g of starch are mixed with the appropriate amount of distilled water until dissolution occurs. If no dissolution occurs, the solution is heated.
- After obtaining a homogeneous mixture, methyl cellulose + triethyl phosphate is added to the hydroxyapatite slurry, which is mixed under control.
- The mud is mixed for 24 hours to obtain stabilization.

3.5 Preparation Of Tissue Scaffolds By The Replica Method

- Sponges to be used for impregnation are cut as 1*1*1 cm.

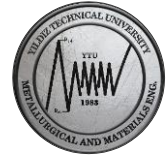

- Sponges are immersed in ceramic mud and waited until they absorb the mud. Then excess of the sludge is removed by air spraying.
- Ceramic-impregnated sponges are first dried at 60-80°C. Then sintering process is carried out as follows;
 - (a) Samples are heated to 300°C in 1 h and kept at this temperature for 1 h,
 - (b) Then the temperature is increased to 1200°C in 5°C/min intervals and kept at this temperature for 5 h to produce bioceramic scaffolds.

4 RESULTS AND DISCUSSION

4.1 Calculations and Assignments

Prepare a report containing your observations and experimental results in all steps of the ceramic tissue scaffolding production experiment. Provide information on the types of grafts and scaffold production methods in the literature section of the report.

5 REFERENCES

- [1] J.R. Jones, L.L. Hench, Regeneration of trabecular bone using porous ceramics, *Curr. Opin. Solid State Mater. Sci.* 7 (2003) 301–307. doi:10.1016/J.COSSMS.2003.09.012.
- [2] S. Sankar, C.S. Sharma, S.N. Rath, S. Ramakrishna, Electrospun nanofibers to mimic natural hierarchical structure of tissues: application in musculoskeletal regeneration, *J. Tissue Eng. Regen. Med.* 12 (2018) e604–e619. doi:10.1002/term.2335.
- [3] No Title, (n.d.). <https://en.wikipedia.org/wiki/Bone>.
- [4] P. Chocholata, V. Kulda, V. Babuska, Fabrication of scaffolds for bone-tissue regeneration, *Materials (Basel)*. 12 (2019) 568.
- [5] A.Y. ARİKAN, A.T.D. KARAKEÇİLİ, Doku iskelelerinin süperkritik karbondioksit ortamında hazırlanması ve karakterizasyonu, Ankara Üniversitesi Fen Bilimleri Enstitüsü Kimya Mühendisliği Anabilim Dalı, n.d.
- [6] R. Narayan, *Biomedical materials*, Springer Science & Business Media, 2009.
- [7] U.G. Sampath, Y.C. Ching, C.H. Chuah, J.J. Sabariah, P.-C. Lin, Fabrication of porous materials from natural/synthetic biopolymers and their composites, *Materials (Basel)*. 9 (2016) 991.
- [8] I.J. Kim, J.G. Park, Y.H. Han, S.Y. Kim, J.F. Shackelford, I.J. Kim, J.G. Park, Y.H. Han, S.Y. Kim, J.F. Shackelford, Wet Foam Stability from Colloidal Suspension to Porous Ceramics: A Review, *J. Korean Ceram. Soc.* 56 (2019) 211–232.
- [9] D. Rana, G. Ratheesh, S. Ramakrishna, M. Ramalingam, Nanofiber composites in cartilage tissue engineering, *Nanofiber Compos. Biomed. Appl.* (2017) 325–344. doi:10.1016/B978-0-08-100173-8.00013-2.
- [10] S. Maeda, T. Kato, H. Kogure, N. Hosoya, Rapid response of thermo-sensitive hydrogels with porous structures, *Appl. Phys. Lett.* 106 (2015) 171909.
- [11] A.S. Çakmak, Biyofiziksel ve Biyokimyasal Uyarımlarla Desteklenmiş Doku



2022-2023 Spring MSE3952 Laboratory II
Experiment 5: Bioceramic Scaffold Production

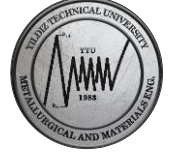

İskeleleri ile Mezenkimal Kök Hücrelerin Osteojenik Farklılaşmasının İncelenmesi, Fen Bilimleri Enstitüsü, 2014.

EXPERIMENT 6: PRODUCTION OF COMPOSITE MATERIALS

1. PURPOSE OF THE EXPERIMENT

Production of E-Glass reinforced composite plates with plastic matrix and fracture analysis by making impact test on samples taken from these plates.

2. THEORETICAL INFORMATION

2.1. Principles of Experiment

The new material group formed by at least two different materials by forming an interface between them without chemical bonding is called composite. Basically, composite materials have two main components.

The matrix phase forms the main component of the composite material. Its main task is to hold the structure together stably by wrapping around the reinforcement (fiber) component. Another task is to transmit and distribute any applied force to the reinforcement phase through the interface bond without being destroyed. An ideal matrix material should be able to coat the fibers very well by surrounding them properly.

The main load-bearing element in composites is reinforcing fibers. Glass fibers are the most widely used and the cheapest type of reinforcement. Aramid and carbon fibers are reinforcement types with high mechanical properties and high cost. Reinforcements can also be available in different forms. Figure 1 shows the classification of composites according to their reinforcement shape and distribution. In Figure 2, the situations of these species in the structure are exemplified. Finally, different weaving types are shown in Figure 3.

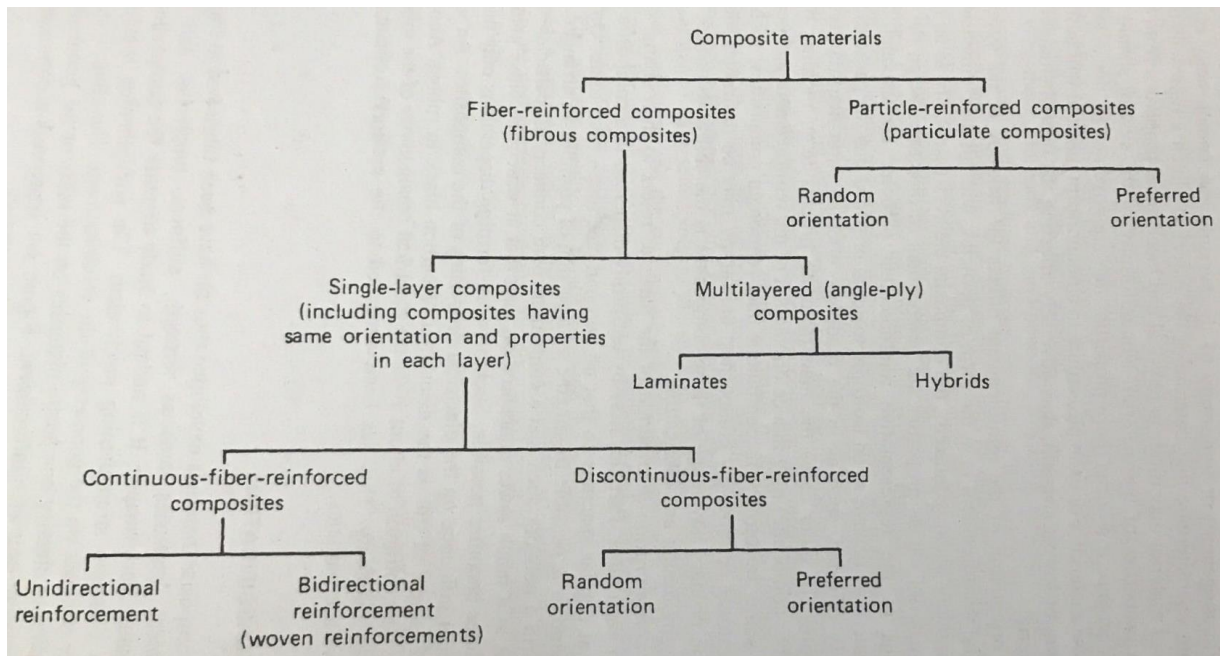

Figure 1. Classification of composites according to reinforcement shapes and distributions

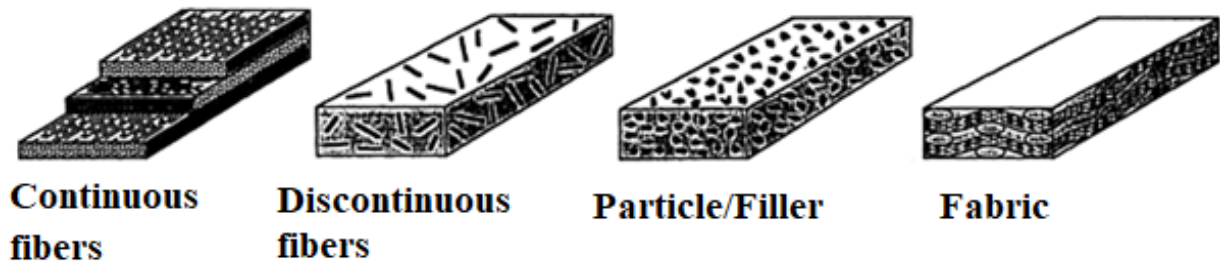

Figure 2. Various reinforcement types

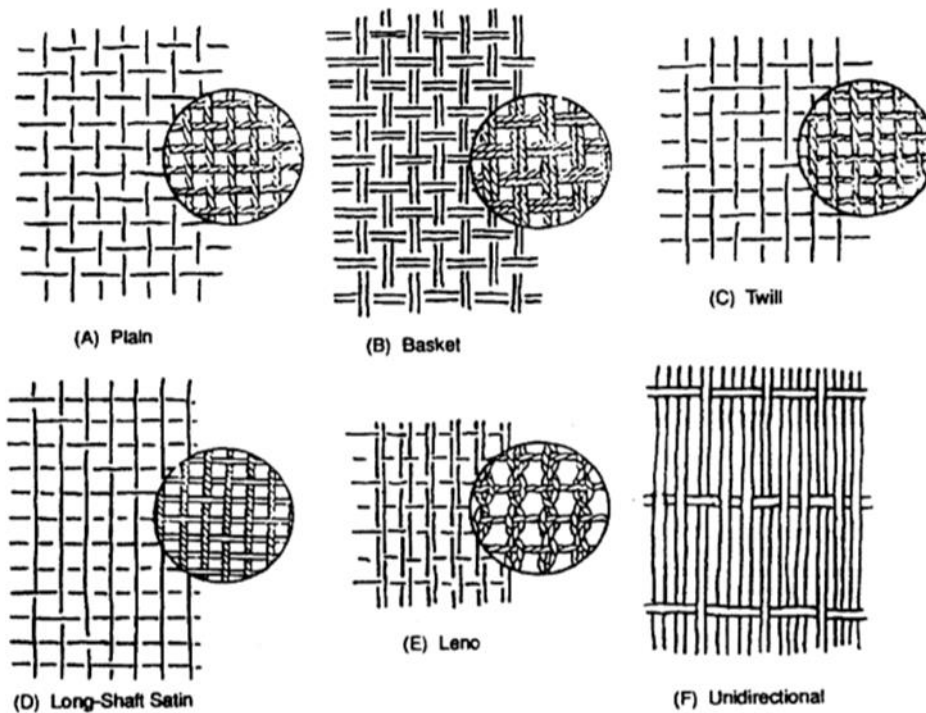

Figure 3. Various woven fabric types

2.2. Classification of Composite Materials According to Their Matrices

- **Plastic Matrix Composites (PMCs):** It is the most widely used composite type today. It has approximately 97 % utilization rate in all composites. They can be reinforced with continuous or discontinuous fibers, or they can be reinforced with particles.
- **Metal Matrix Composites (MMCs):** It is the most used group after plastic matrix composites. Metal matrices, which are generally used as particle-reinforced, have applications in where wear resistance is required. In addition, honeycomb structure produced from aluminum is included in this group.
- **Ceramic Matrix Composites (CMCs):** They are not widely used. Unlike other groups, it has a brittle matrix. Composites in this group are reinforced with ductile fibers to increase the toughness of the brittle matrix.

2.3. Plastic Matrix Composites

Plastic matrix is the most widely used composite type with many advantages. Therefore, it is important to know the plastic to learn the properties of the composite. Plastics consists of repeating of molecules of simple molecules formed by carbon, hydrogen, oxygen, nitrogen and other organic or inorganic elements. The plastic matrix is generally divided into two groups:

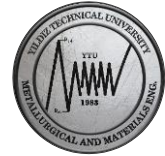

a) Thermosets: Epoxy, polyester, vinylester, phenolic resins

b) Thermoplastics: PE (polyethylene), PP (polypropylene), PS (polystyrene), PET (polyethylene terephthalate), PBT (polybutylene terephthalate), PA (polyamide), PPS (polyphenylene sulfide), PEEK (polyether ether ketone)...

According to the reinforcement, a classification can be made as follows:

- Plastic-Plastic Composites
- Plastic-Metal Composites
- Plastic-Ceramic Composites
- Plastic-Foam Composites

2.4. Production Methods of Plastic Matrix Composites

Hand Lay-Up Method: It is the most widely used method for the production of large-area thermoset matrix composites. After the release agent is applied, the gelcoat is applied. After the gelcoat layer has hardened, chopped-strand mat fabrics or woven fiber fabrics and thermosetting resin are applied with a brush or roller. Reinforced plastic product can be obtained at a rate of 25 - 35% by hand lay-up, which is a molding method that requires low fixed capital investment. Since it is a labor-intensive production method, capacity depends on the number of labor and molds. An average of 2 products can be taken per day from a mold.

Spray-Up Method: It is a molding method that enables the hand lay-up method to be applied more rapidly. During production, resin and fiber are sprayed on the mold with the help of a special machine. In the spraying method, the continuous fiber bundle is used by chopping 17-50 mm in length during the spraying process. It provides mass production opportunity and labor saving in large surface products.

Vacuum Bagging and Autoclave: These are the methods applied to increase the properties of the composite after hand laying or spraying. A vacuum blanket is placed on various separation fabrics to absorb excess resin on resin composite products that have not been cured in vacuum bagging. A heat-resistant film called vacuum bag is placed at the top by attaching a vacuum nozzle and is closed with a special paste to ensure impermeability. The system is put into vacuum and vacuum continues to be applied until the curing process is complete. Excess resin is passed through the product, increasing the fiber volume ratio, thinning the section and decreasing the weight, eliminating the voids and increasing the mechanical properties as a result. Similarly, in the autoclave, uncured products are vacuumed by taking the vacuum bagging system. Then, curing is achieved by giving heat and pressure in autoclave ovens.

Vacuum Infusion: Chopped-strand mat fabrics or woven fiber fabrics are placed on top of each other and taken to the vacuum bagging system. However, in the vacuum bag, in addition to the vacuum opening, the openings through which the resin will enter are opened. As the system is put into vacuum, the resin starts to fill into the inside of the bag and wets the fibers to form the composite.

Resin Transfer Molding (RTM): In this production method, two-sided products are obtained by using two molds, male and female. Fiber fabrics are placed on the mold and the molds are closed. Thermoset resin is injected into the mold under pressure from a pre-prepared resin injection point. With the resin injection method, a higher quality product is obtained more quickly and economically than hand lay-up method.

Sheet Molding Compound / Bulk Molding Compound (SMC/BMC): It is a method of forming fiber, resin and filling material mixtures in hot press molds at 150 - 170°C and 50 - 120 kgf/cm²

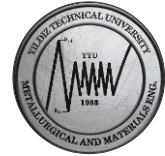

pressure. Complex shaped products can be obtained. It is a fast and rapid method of 3 - 6 minutes. In SMC, long chopped by pre - combining long-cut (25 - 50 mm) fibers with filling and resin is used, while in BMC, short - chopped (3 - 12 mm) fiber, filling and resin combination is used.

Filament Winding: It is a molding method used especially for the production of pipes and tanks. It is in the form of winding continuous fiber bundles on a rotating mold at certain angles after wetting from the thermoset resin bath.

Centrifugal Casting: It is used in the production of cylindrical products such as pipes, tanks, poles. The chopped fiber and thermosetting resin are sprayed together into a rotary die. The centrifugal force resulting from the rotation of the mold ensures that the laminate adheres to the mold surface and obtains a smooth product on both sides.

Pultrusion: It is based on the principle that continuous fiber bundles are hardened while being drawn through a hot mold in the desired profile after passing through a thermoset resin bath. In the direction of fiber reinforcement, very durable profile products with a very high glass fiber content are obtained.

Thermoplastic Injection / Extrusion Method: While extrusion machines are used for molding profile type products, injection machines are used for molding complex shaped products. In injection and extrusion machines working with the same principle, the granular thermoplastic raw material supplied from the feeding chamber is heated in the heating zone, making it fluid, and short-cropped fiber is fed on the one hand. Then, a homogeneous mixture is provided with the auger grooves on the one hand, and it is carried towards the outlet end on the other hand. In extruders, profiles are drawn in accordance with the shape of the mold with the help of pressure effect and pulling apparatus through the mold placed at the exit end, while in injection machines, short clipped fiber mixed with fluidized thermoplastic is injected into the closed mold located right next to the exit nozzle, and it is cooled and hardened in a closed mold.

2.5. Glass Fiber Production

Glass fiber is produced from conventional glass production raw materials such as silica, colemanite, aluminum oxide, soda, magnesium oxide. The raw material is finely ground and mixed to obtain a homogeneous mixture and fed to a melting furnace operating at about 1600 °C. Here, the mixture slowly becomes liquid. With a winding system suitably placed in the process, a high velocity of 50 - 70 m/s and a 5 - 20 micron diameter glass fiber are collected on a bobbin by winding on the mandrel, depending on the type of application.

The glass fibers are coated with a chemical composition, called a binder, before being bundled. The type of binder is one of the most important factors affecting the performance of glass fiber in the composite material. The strength of the composite is proportional to the strength of the resin-glass bond. The strength of this bond depends on the type of binding groups in the binder used. The binder consists of a mixture of "film-forming", "binding groups", "antistatic additive", "plasticizer" "lubricant" materials.

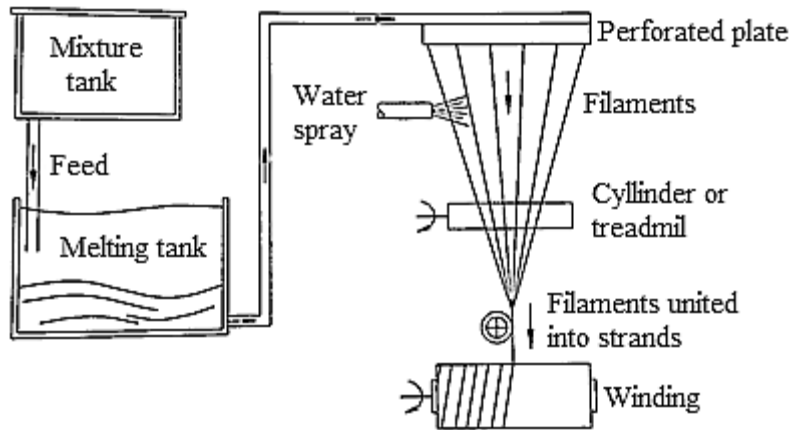

Figure 4. Schematic drawing of glass fiber production

3. EXPERIMENTAL STUDIES

3.1. Tools and Devices Used

- Fiber reinforced composite samples in accordance with test standards
- Digital Caliper
- Impact Device

3.2. Kullanılan Standartlar ve Metotlar

- TS EN ISO 527-4: Plastics - Determination of Charpy impact properties - Part 1: Impedance impact test
- TS EN ISO 14125: Plastic composites - fiber reinforced - determination of bending properties
- TS EN ISO 179-1: Plastics - Determination of Charpy impact properties - Part 1: Toolless impact testing

3.3 Materials Used

- Reinforcement element: E-glass weave or mat fabric
- Matrix material: Orthophthalic based unsaturated polyester resin
- Resin accelerating agent: Cobalt octoate
- Resin initiating agent: Methyl Ethyl Ketone (MEK) Peroxide
- Dosing pipettes
- Resin Mixing Bowl
- Mixer Mold
- Mold release agent
- Brush
- Acetone or thinner
- Plastic glove

3.4. Experimental Procedure

1. The mold release agent is applied to mold and left to dry.
2. The reinforcing material to be used is cut into appropriate sizes and its weight is measured.
3. Twice amount of resin is prepared in a container by mixing with accelerator and the initiating agent at a required ratio. (The accelerator and initiator should not be placed at the same time because they react violently with each other!)
4. Apply a small amount of resin with a brush onto the dried mold release agent.

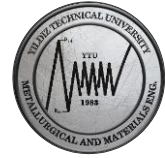

5. A layer of reinforcing fabric is placed on it.
6. Resin is applied by light pressure on the reinforcing fabric with brush.
7. Put the second layer of reinforcing fabric and repeat the process until required thickness is obtained.
8. Wait until the resin is cured.
9. Clean the brushes, containers and pipettes with acetone.

3.5. Sample Preparation and Impact Test

The dimensions of the samples with different layer thicknesses will be measured, and the cross-sectional area will be calculated by taking the minimum value from the three measurements. Each student will do this step using the digital caliper. The test shall be carried out by placing the sample in the impact device. Impact energy will be measured, samples will be compared and fracture patterns will be examined.

4. RESULTS AND DISCUSSION

4.1. Experimental Results and Discussion

Composite part production stages will be observed in detail. Materials with different layer thicknesses will be compared. As a result of the experiments, fracture analyzes will be made on the samples. As a result of the examinations made on the sample fracture sections, fiber pull-out and delamination problems will be observed, which the main damage causes of the composites are.

4.2. Calculations and Assignments

The impact energy will be read on the device in Joules (J), and the impact strength will be found by dividing the sample cross-sectional area.

4.3. Information Required In the Experiment Report

1. Definition, classification, types and examples of composite materials.
2. General information about plastic materials used as matrix materials, types, examples.
3. Short information about the production methods of plastic matrix composite materials.
4. General information about glass fibers.
5. Identification of materials used.
6. Application of composite production.
7. Calculation of the impact strength.
8. Comparison of the results of the samples.
9. Fracture analysis.
10. Specifying the sources used at the end of the report.

5. REFERENCES

- [1] Autar K. Kaw, Mechanics of Composite Materials, Taylor & Francis Group, 2006
- [2] Robert M. Jones, Mechanics of Composite Materials (2. Edition), Taylor & Francis, 1999
- [3] Sanjay K. Mazumdar, Composites Manufacturing: Materials, Product, and Process Engineering, CRC PRESS, 2001
- [4] Alan Baker, Stuart Dutton, and Donald Kelly, Composite Materials for Aircraft Structures Second Edition, American Institute of Aeronautics and Astronautics, 2004
- [5] Peters, S.T., Handbook of Composites (2nd Edition), Kluwer Academic Publishers, 1998



2022-2023 Spring MSE3952 Laboratory II
Experiment 6: Production of Composite Materials

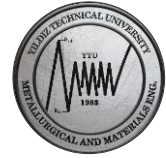

- [6] A.R. Horrocks & S.C.Anand, Handbook of Technical Textiles, Woodhead Publishing Limited, 2000
- [7] Hull, Derek, An Introduction to Composite Materials, The Press Syndicae of the University of Cambridge, 1981 www.camelyaf.com

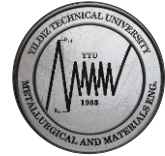

EXPERIMENT 7: REDUCTION ELECTROLYSIS

1. AIM OF THE EXPERIMENT

In this experiment; It is aimed to learn the electrolysis phenomenon, to learn the refining (purification) and reduction (recovery) processes of copper and to obtain electrolytic copper by using copper in solution.

2. THEORETICAL INFORMATION

Electrometallurgy

It is called "Electrometallurgy" to produce metals in all kinds of raw materials containing ore or metal by using electrical energy. In reality, electrometallurgy is an application of electrochemistry. Here, electrochemistry methods are applied to metals.

Electrolysis

It is the phenomenon of the liberation of metal ions at the cathode and non-metallic ions at the anode as a result of chemical decomposition by passing an electric current through aqueous or molten electrolytes. Ions are discharged at the electrodes; It can be liberated, collected as an element, and react with the electrode.

Electrode: Conductor that conducts electric current to liquid, solid and gas phases. In an electrochemical sense, the electrode is the system that combines the electrode conductor and the ionic conductor.

Electrolyte: It is the environment that contains (+) and (-) charged free ions. It is the liquid that conducts the electric current used in electrolysis. Molten salts and solutions of acids, bases and salts are used as electrolytes.

Electrolysis cell: Cells in which electrical work is converted into chemical work by applying external voltage.

Generator: It is a direct current source that provides electrical energy in the external circuit. The electrode connected to the positive pole of the generator is the anode, and the electrode connected to the negative pole is the cathode.

In electrolysis; cations (+ charged ions) are reduced to the cathode, and anions (- charged ions) are oxidized to the anode. If there is more than one type of cation in the electrolysis vessel, the one with the greatest reduction potential (potential) is reduced first. Then the reduction continues sequentially. If there is more than one type of anion in the electrolysis vessel, the anion with the greatest oxidation tendency is collected at the anode first. The less active anion is first released at the anode, and the less active cation is first released at the cathode. In electrolysis, compounds can be separated into their elements. If a voltage higher than the battery voltage is applied to the electrochemical cell, the reaction in the battery is reversed. Electrolysis occurs. This phenomenon is called charging the battery.

The electrolysis process is carried out in a cell called an electrolysis vessel or tank. This cell consists of two electrodes immersed in a compound that dissolves into positively and negatively charged ions, and these electrodes are arranged so that they do not touch each other (usually 5-20 cm between the two electrodes). In order to carry out the electrolysis process, these electrodes are connected to a direct current source and the voltage (electric field) between the electrodes moves the ions towards the oppositely charged electrode (pole). Therefore, (+) charged ions go to the cathode, while (-) charged ions flow towards the anode. Atoms or

molecules that balance their charge at the opposite pole precipitate on the electrode or enter into new reactions with the molecules in the electrolyte.

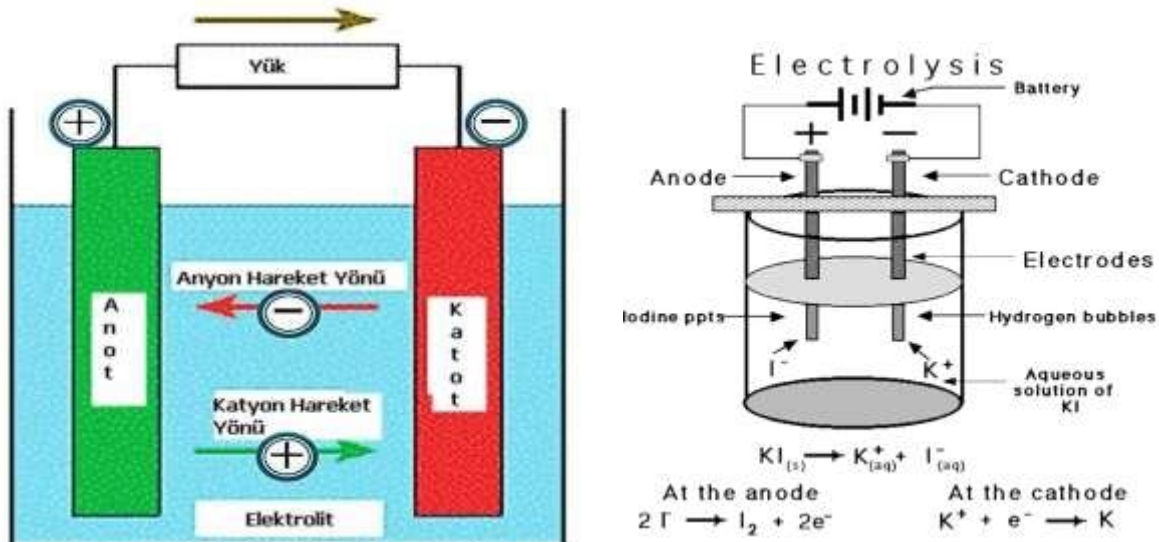

Figure 1. Electrolysis Method

Electrolysis of copper (Cu) in industry is used for two purposes. One of them is the purification of copper, which is carried out in order to collect the impure copper metal from the impurities in it and collect it on the cathode; The other is the copper recovery process to recover the copper metal from aqueous solutions.

Application Areas of Electrolysis

Electrolysis processes, as mentioned earlier, are used in the field of metallurgy by electrolysis, in the preparation (method using insoluble anode-recovery electrolysis) or refining (method using soluble anode-purification electrolysis) of metals. It is also a method of protecting against corrosion by an electrolytic metal deposit and coating metals with a metal deposit (for example, nickel plating, zinc plating, cadmium plating, chrome plating, silver or gold plating). Pure hydrogen is also obtained, in particular, by the electrolysis of water. Application areas include gas production (chlorine), obtaining anode layers with protective oxides on metal (the process of anodizing aluminum by means of alumina), electropolishing, degreasing of metals as cathode or anode. Electrolysis also allows the measurement of current intensities, especially current amounts in voltmeters. Treatment electrolysis, which is based on the separation of organic tissues with the help of continuous current, is also used in medical applications such as the destruction of nerve endings (neurons), hardened tumors, polyps in the nostrils, and the treatment of urethra or esophagus narrowing.

Refining (Purification) Electrolysis of Copper

The refining electrolysis of copper is an electrolysis process that enables to obtain refined copper of sufficient purity, and this process is carried out with soluble copper anodes. Copper sulfate (CuSO₄) and H₂SO₄ solution are used as electrolytes. One of the copper electrodes immersed in the solution is pure copper, while the other is impure copper. As the (+) charged anode, copper (blister copper) electrodes obtained by purification at high temperatures (98-99% purity) are used. These electrodes contain O, S, Au, Ag, Pt and various amounts of As, Sb, Bi,

Sn, Se, Te, Pb, Zn, Fe as impurities in their composition. As the (-) charged cathode, titanium plates coated with electrolytic copper or copper plates (99.5% purity) coated with oil to prevent sticking are used. While electrons flow from the anode to the cathode out of the electrolyte; They flow from the cathode to the anode in the electrolyte. Under suitable conditions, the anode oxidizes and goes into solution and is reduced at the cathode. Some of the other impurities in the anode do not dissolve, they break off from the anode and collect at the bottom of the cell. This residual material is called “anode mud”. Some impurities dissolve into the electrolyte. Since the anode and cathode are of the same composition, the separation voltage is theoretically zero and the cell voltage is slightly above the electrolyte resistance.

Electrolytic refining is done for two reasons. While the main purpose is to get rid of impurities that cause a decrease in conductivity, noble metals and semi-metallic metals (Se,Te) that pass into the anode sludge during the refining process add value to the business as they cover the cost in the refinery.

When current is applied between the anode and the cathode, the following occurs in the $\text{CuSO}_4\text{-H}_2\text{SO}_4\text{-H}_2\text{O}$ type electrolyte:

The operating conditions of classical copper purification electrolysis are 0.2-0.35 V cell voltage. The electrolysis conditions are as follows:

- 35-50 g/l Cu and 140-220 g/l H_2SO_4 in electrolyte
- Temperature 50-65 °C
- Cathode current density 150-250 A/m² (15-25 mA/cm²)

Reactions occurring in the purification electrolysis of copper;

Anode reaction: $\text{Cu} \rightarrow \text{Cu}^{2+} + 2\text{e}^-$ (Here, copper dissolves as Cu^{2+} ions as a result of anodic oxidation.)

Dissolved (+) charged copper ions (Cu^{2+}) reach the cathode surface.

Cathode reaction: $\text{Cu}^{2+} + 2\text{e}^- \rightarrow \text{Cu}^0$ (Here Cu^{2+} copper ions are reduced to metal state by recombining with electrons transferred from the anode.)

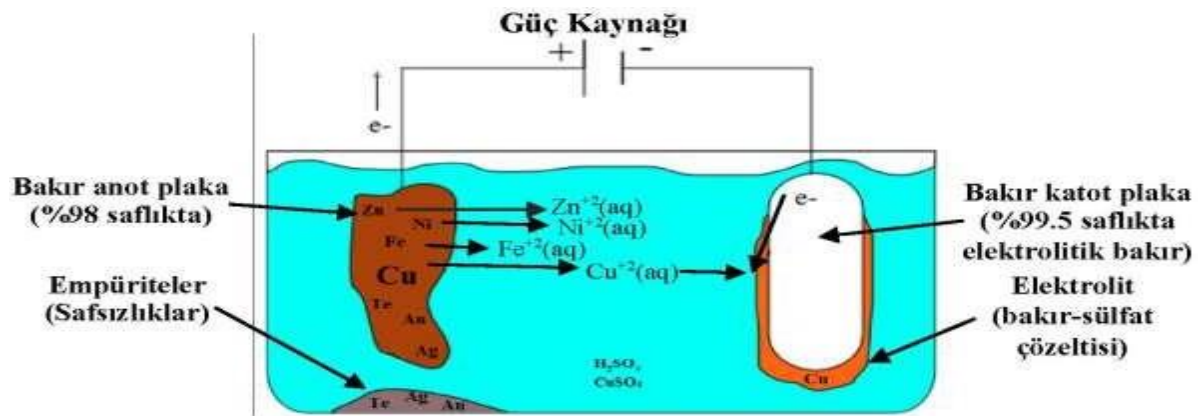

Figure 2. Purification electrolysis of copper

Among these options, it is seen that there is no energy consumption in copper refining electrolysis. However, since the anodic and cathodic reactions are kinetic impediments, excessive voltages must be applied, and the voltage drop due to the resistors at the junctions must also be considered.

Reduction (Reduction) Electrolysis of Copper

Recovery electrolysis of copper is an electrolysis process that provides copper from solutions, and insoluble anode and cathode electrodes are used during this process. While a hard lead alloy containing 4-6% Sb is used as the anode, stainless steel and recently titanium plates are used as the cathode. For the reduction process, a temperature of 40-60 °C and a current density of 70-150 A/m² are selected. During electrolysis, (-) charged ions in the solution go to the anode, and (+) charged ions go to the cathode. Anions are oxidized at the anode surface, while cations are reduced at the cathode surface. Thermodynamically, copper reduction electrolysis takes place at 0.89 V.

Reactions during reduction electrolysis of copper; $\text{CuSO}_4 + \text{H}_2\text{O} \rightarrow \text{Cu} + \text{H}_2\text{SO}_4 + \frac{1}{2}\text{O}_2$

Anode reaction: $\text{SO}_4^{2-} + \text{H}^+ + 2\text{e}^- \rightarrow \text{H}_2\text{SO}_4 + \frac{1}{2}\text{O}_2$

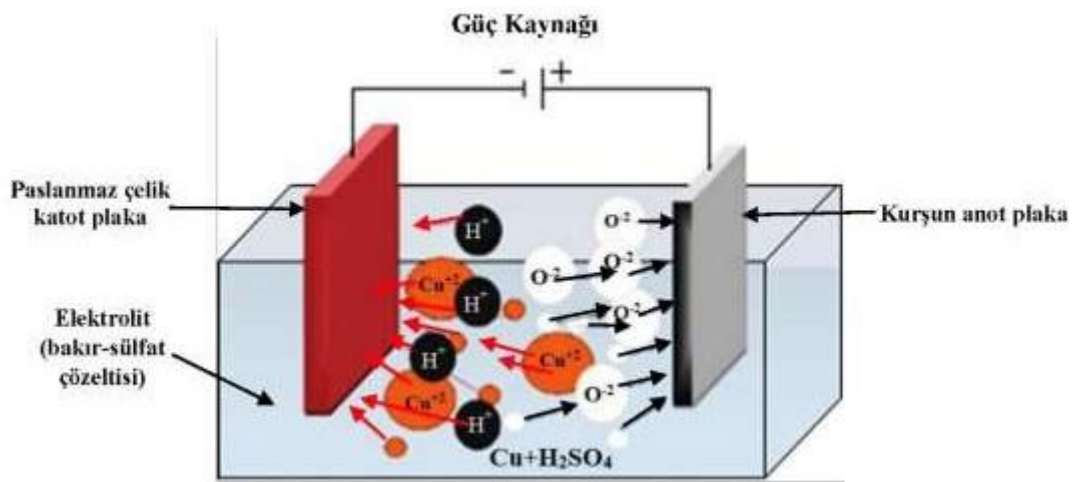

Figure 3. Recovery electrolysis of copper

One of the differences between the purification and recovery electrolysis of copper is that the 'cathode' reactions are the same but the 'anode' reactions are different. In addition, in the electrolysis of copper purification, metal ions dissolved from the anode are reduced at the cathode; In the recovery electrolysis of copper (as an insoluble lead alloy containing 4-6% Sb is used), the anode reaction takes place by oxidation of an anion or molecule in the electrolyte.

Electrolysis Conditions and Additives

Colloid is a homogeneous mixture. This homogeneous mixture contains gelatin and thiourea. Gelatin provides homogeneous and uniform bonding of copper to the cathode surface and creates a fine crystalline hard copper structure. Thiourea is used to eliminate the side effects of gelatin. Another task of the thiourea is to isolate the spikes and pits on the cathode surface. Another additive, mersolate, acts as an antioxidant and delays sulfation on the cathode surface. The purpose of adding HCl to the homogeneous mixture is to precipitate silver ions (Ag⁺) in the electrolyte as silver chloride (AgCl).

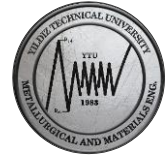

Table 1. Electrolysis conditions and additives

Parameters	Conditions
The copper concentration in the electrolyte	35-50 gr/l
H ₂ SO ₄ concentration in the electrolyte	140-220 gr/l
Temperature	50-65 °C
Cathode Current Density	150-250 A/m ²
Cell Voltage	0,2-0,35 V
Circulation Rate	0,02 m ³ /dak.
Colloids Gelatine	0,0001-0,001 kg/m ³
Thiourea	0,0001-0,001 kg/m ³
HCl or NaCl	0,035 kg/m ³

3. CALCULATIONS

In an electrolysis circuit, the amount of product that should be theoretically obtained at the end of the process by the passage of the 'I' current for 't' time is calculated by the Faraday equation:

$$MT = (I \cdot t \cdot Ma) / (Z \cdot F) * ;$$

In this equation,

MT = The amount of product obtained (accumulated at the cathode), I = The current intensity (A) passed through the circuit,

t = Time (sec),

Ma = Atomic weight of the substance deposited at the cathode (for Cu: 63 gr/mol), Z = Valence of the substance deposited at the cathode in the compound (for Cu: 2),

F = Faraday's constant (96500 Coulomb).

In electrolysis processes, the current density is calculated by the ratio of the current flowing through the circuit to the area of the cathode electrode immersed in the electrolyte:

$$\text{Cathode Current Density} = \text{Current Through Circuit} / \text{Area of the Cathode Remaining in Electrolysis}$$

Since some of the current flowing through the circuit is used to overcome the resistances during the experiments, the product obtained by electrolysis is less than the theoretical product. As a result of multiplying the ratio of the obtained product (Mg) to the theoretical product (MT) by 100, ** $\beta = [(MG / MT) \times 100]$, % current efficiency (efficiency) is obtained. If the amount of

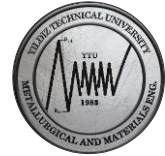

material collected at the cathode or separated from the anode is equal to the theoretical value calculated by the Faraday equation, it is understood that the current efficiency is 100%, and if not, it is below 100%. In addition, the value obtained as a result of $[(MT-MG)/MT] \times 100$ gives the experimental % error margin.

Case Study;

a-Refining Electrolysis

Before starting the experiment, the electrolyte liquid was prepared using the data in Table 1. The prepared electrolyte was placed in the beaker. Then the cathode plate was cleaned with alcohol and dried and its weight was measured on a precision balance. The temperature of the prepared electrolyte was increased to 65°C and meanwhile magnetic stirrer was started. The current density was calculated by measuring the surface area of the cathode plate in the electrolyte. The prepared anode and cathode plates were connected to the power source and the current was given according to the calculated current density. After the electrolysis process took 15 minutes, the power supply was turned off just in time. The cathode plate was removed from the electrolyte, cleaned and dried with alcohol, and its final weight was measured on a precision balance. Then, the theoretical copper amount to be obtained during the experiment was calculated using the (*) equation. The current efficiency was calculated using the equation (**) to calculate the electrolysis efficiency.

b- Reduction Electrolysis

The electrolyte used in refining electrolysis was used in reduction electrolysis. Lead plate was used as the anode plate and steel plate was used as the cathode plate. After the cathode plate was cleaned with alcohol and dried, its weight was measured on a precision balance. Then, the surface dimensions of the part that will remain in the electrolyte were measured and connected to the power supply with the anode positive and the cathode negative. The voltage was increased by keeping the current applied to the refining electrolysis constant. After the electrolysis process took 15 minutes, the power supply was turned off just in time. After the cathode plate was removed, cleaned with alcohol and dried, the final weight was weighed. Then, the amount of copper to be collected during the electrolysis was calculated according to the (*) equation. To calculate the electrolysis efficiency, the current efficiency was calculated using the equation (**)

c-Example Interpretation

The yield (99.2%) we obtained as a result of refining electrolysis showed that the experiment was carried out correctly. However, in reduction electrolysis, more copper was collected than the theoretically required amount. The reasons for this may be: the current density cannot be adjusted exactly or the anode and cathode plates are closer to each other than they should be.

The copper mined in the refining electrolysis was obtained by dissolving the fire-refined anode plate with a purity of 98-99%. On the other hand, in reduction electrolysis, the copper in the electrolyte is recovered. One of the differences between refining electrolysis and reduction electrolysis is the anode plate used. Lead plate was used in reduction electrolysis and there was no dissolution of the used plate.

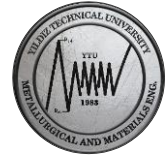

The reason for using a lead plate is that the lead remains on the anode surface directly forming insoluble PbSO₄. If the anode copper contains too much lead, the resulting PbSO₄ completely covers the surface and causes the anode to passivation.

Another difference is the anode reactions that occur. While metal ions dissolved from the anode are reduced at the cathode in refining electrolysis, since insoluble anodes (usually lead alloys containing 4 – 6% Sb) are used in reduction electrolysis, the anode reaction must be achieved by oxidation of an anion or molecule in the electrolyte. The oxidation process is a task undertaken by the OH⁻ ion, which is formed as a result of the dissociation of water in aqueous solutions. The refining and reduction electrolysis anode reactions are given below.

Although lead is a basic metal; Explain the reason and/or reasons why copper is used as an anode material in reduction electrolysis, accompanied by related reactions.

When we look at the EMF series, we can see that lead is more basic than hydrogen, and copper is more noble. With this simple approach, we can say that lead will dissolve if it is used as an anode during copper reduction electrolysis. However, in lead and copper reduction electrolysis, PbO and PbSO₄ formed by the breakdown of water, and this PbO makes the H₂SO₄ solution and PbSO₄ compound. These compounds coat the lead anode surface and form a stable anode surface. As a result, lead is insoluble and is therefore used as an anode material.

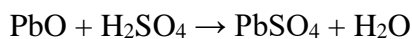
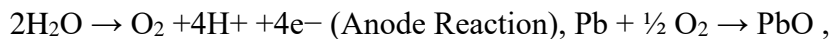

4. MATERIALS AND DEVICES USED IN THE EXPERIMENT

- Electrolysis cell,
- Direct current power supply (voltmeter, ammeter and connection cables),
- Copper-sulphate and sulfuric acid solution (35-50 g/L Cu-containing solution in Electrolyte, 140-220 g/L H₂SO₄), alcohol (for cleaning), gelatin powder and thiourea (0.001 g) as additives
- Precision scales,
- Beakers,
- Cathode electrolytic copper and anode blister copper (purified at high temperatures) plates (for purification electrolysis),
- Cathode stainless steel and anode lead plates (for recovery electrolysis),
- Heater, magnetic stirrer, caliper. Duties of additives:

Gelatin: It creates a fine crystalline hard copper structure by ensuring that the copper deposited on the cathode is properly and homogeneously bonded to the surface.

Thiourea: Eliminates the side effects of gelatin and isolates the spikes and pits on the surface of the cathode material.

5. CONSTRUCTION OF THE EXPERIMENT

The electrolyte solution is prepared by weighing the specified amounts of copper-sulphate (CuSO₄) and H₂SO₄ and put into the beaker. Specified amounts of gelatin powder and thiourea are added to the solution and mixed. The material from which the metal will be collected (cathode plate) is cleaned with alcohol and dried, and the result is recorded by weighing it on a precision scale. The anode and cathode electrodes are placed in the electrolyte solution. The connection cable of the anode plate to the (+) pole of the DC power supply; The connection

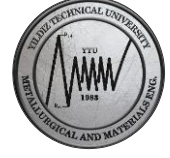

cable of the cathode plate is attached to the (-) pole. Considering 150 A/m² in both copper purification and recovery electrolysis experiments as current density, the area of the part of the cathode plate immersed in the electrolyte is calculated, and after determining the amount of current to be switched, the DC power supply is operated and the circuit is energized. The electrolysis process continues for 15 minutes and the power supply is turned off according to the exact time, and the current supplied to the circuit is cut off. The cathode plate is cleaned with alcohol as in the beginning, dried and its final weight is re-weighed. The amount of material collected at the cathode is determined and compared with the amount that should theoretically accumulate, the current efficiency and experimental error margin are calculated with the help of the equations given above. The execution of both experiments is carried out in the same way.

6. RESOURCES

- [1] POPOV K.I., DJOKIĆ S.S., GRGUR B.N., “Fundamental Aspects of Electrometallurgy”, 2002
- [2] YTÜ Metalurji Müh., “Demir Dışı Metal Üretimi Laboratuar Kitapçığı”, 1997
- [3] EKERİM, A., Elektrometalurji Ders Notları, 2010
- [4] BOR, F.Y., “Ekstraktif Metalurji Prensipleri Kısım II”, Birinci Baskı, 1989
- [5] Arslan, F. , Arın T. , “Elektroliz Deney Föyü” KTÜ Metalurji ve Malzeme Mühendisliği Bölümü, Trabzon 2010
- [6] Alver, Ü., Sarı, A., Güler, O., Elektroliz Yöntemi İle Metal Saflaştırma ve Geri Kazanımı, KTÜ Metalurji ve Malzeme Müh. Böl. Laboratuar Föyü, 2016
- [7] İncekara M. , “Elektroliz Yöntemiyle Bakır Tozu Üretilmesi” , Karabük Üniversitesi Fen Bilimleri Enstitüsü, s. 69-79, 2008
- [8] Güzey G. , “Elektrometalurjik Yöntemlerle Metalik Bakır ve Bakır-Kalay Alaşım Tozlarının Üretimi ve Üretim Koşullarının Optimizasyonu”, İstanbul Üniversitesi Fen Bilimleri Enstitüsü, s. 12, 13, 14, Haziran 2009
- [9] <http://www.corrosion-doctors.org>
- [10] <http://chemed.chem.wisc.edu>
- [11] <http://www.drkc.n.yzi.me/copper.doc>
- [12] Kocaeli Üni., Kimya Müh., Genel Kimya Laboratuar Föyü
- [13] Tholego P., Aubrey R., Katlego R., Nhlanhla O., Stephen S., Thapelo S., ‘Production of Copper Concentrate and 99.99 % Copper Cathode from Low-grade Copper Ore in Frank’, Environmental and Materials Engineering, University of Leeds, 2012.

EXPERIMENT 8: RECRYSTALLIZATION

1. PURPOSE OF THE EXPERIMENT

To observe the alterations that the recrystallization annealing may provide in the grain structure and the mechanical properties of the cold worked materials. To investigate the effects of the deformation amount, annealing time and temperature on the recrystallization process.

2. THEORETICAL INFORMATION

Cold working, which is also known as work hardening, is the process of strengthening metals through plastic deformation. This is made possible through the dislocation movements that are produced within the crystal structure of the material. Many metal fabrication processes involve cold-working, such as cold rolling sheet and plate, wire drawing, and deep drawing. The crystalline grain structure of cold worked material is distorted. Grains elongate along the direction of the deformation (**Figure 1**).

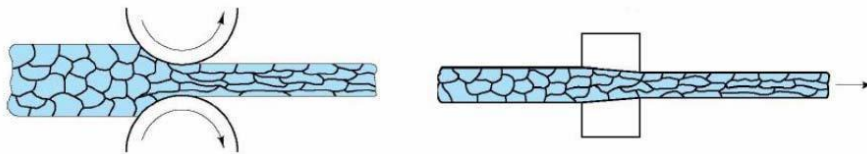

Figure 1: Distortion of the grain structure during the plastic deformation [1]

As a result of the cold working, the density of dislocations and subsequently hardness and strength of the metallic material increase, while its ductility and toughness decrease. This phenomenon is called the strain hardening. During the plastic deformation, the formation of atomic gaps and the increase in the density of these gaps with the increasing deformation amount, causes cracks and ruptures in the material. Therefore, the amount of deformation that can be applied to the material with strain hardening is limited. Furthermore, while the enhanced hardness and strength that the working treatment provides may be useful in specific applications, it is frequently essential to revert the metal to its original condition in order to perform further forming operations. The array of dislocations generated by cold working increases the amount of strain energy stored in the lattice. As a result, compared to the undeformed condition, the cold-worked condition is thermodynamically unstable, and the cold-worked metal will attempt to recover to a state with lower free energy.

Recrystallization refers to the rearrangement and reorientation of the elongated grains to refined equiaxed grains when a metal is heated at its recrystallization temperature. Metallic materials must be deformed with a specific amount to recrystallize at a certain temperature, which is called the critical deformation rate. With increasing amount of deformation, the energy stored in the material increases which favors the nucleation. Hence, when annealed at the same temperature, the metal with the greater amount of deformation recrystallizes more rapidly. Additionally the presence of the alloying elements and their distribution (solid solution or secondary phase) and the grain size of the material after cold work are the parameters effects the recrystallization characteristics. The removal of the cold-worked condition occurs by a combination of three processes, namely, recovery, recrystallization and grain growth [2], [3].

Recovery: The initial cold-worked microstructure is made up of distorted grains with a large number of tangled dislocations. With the increasing temperature, the extra thermal energy allows the dislocations to move and form the boundaries of a polygonized subgrain structure. (**Figure 2b**). This low-temperature treatment, known as recovery, reduces residual stresses caused by cold working without causing an alteration in dislocation density. The mechanical properties of the metallic material remain relatively unchanged since the number of dislocations is not reduced during recovery. Yet, because residual strains are decreased or eliminated when dislocations are repositioned, recovery is commonly referred to as a stress-relief anneal. Additionally, recovery restores the electrical conductivity and improves the corrosion resistance of the material.

Recrystallization: When a metallic material that has been cold worked is heated above a particular temperature, quick recovery reduces residual stresses and generates the polygonized dislocation structure. The nucleation of new small grains at the cell boundaries of the polygonized structure eliminates the majority of dislocations. (**Figure 2c**). Since the number of dislocations is drastically decreased, the strength of the recrystallized metal reduces while its ductility increases. The formation of new grains in a material that has been cold-worked by heating is referred to as recrystallization.

The driving force for recrystallization is the difference between the internal energy between a cold worked material and that of a recrystallized material. The recrystallization temperature is the temperature at which 50% of the recrystallization of a cold-worked material is accomplished within one hour. Typically, this temperature corresponds to 40% melting temperature of the material. However, the recrystallization temperature is not a fixed temperature and is influenced by a variety of processing variables which are given below.

- Recrystallization temperature decreases with the increasing deformation amount. Greater amounts of deformation decreases the stability of the material and favours the nucleation of recrystallized grains.
- A smaller original cold-worked grain size reduces the recrystallization temperature by providing more sites—the former grain boundaries—at which new grains can nucleate.
- Pure metals recrystallize at lower temperatures than alloys.
- Increasing the annealing period lowers the recrystallization temperature, since more time is available for the nucleation and growth of the recrystallized grains.

Grain Growth: Heating the material at a temperature above the recrystallization temperature causes the growth of newly formed grains. (**Figure 2d**). This phenomenon, called grain growth, is driven by the reduction in grain boundary area to reduce the internal energy. Grain growth is generally undesirable since it adversely affects the mechanical properties of the material [4].

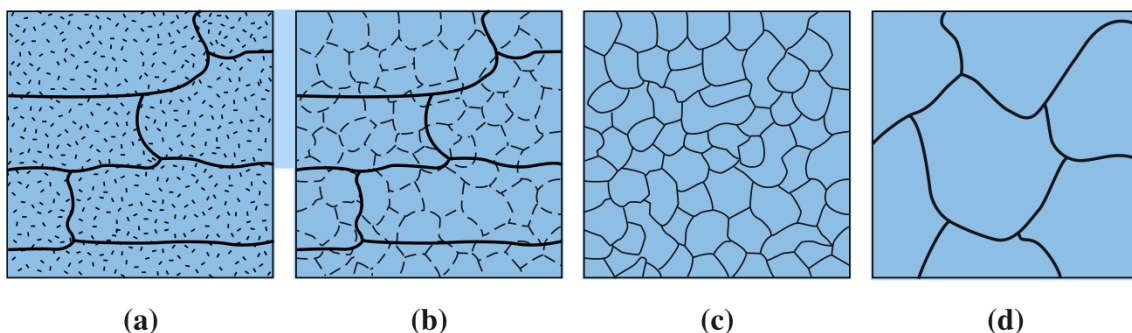

Figure 2: The microstructure of a metallic material, (a) after cold-worked, (b) after recovery, (c) after recrystallization, and (d) after grain growth. [1]

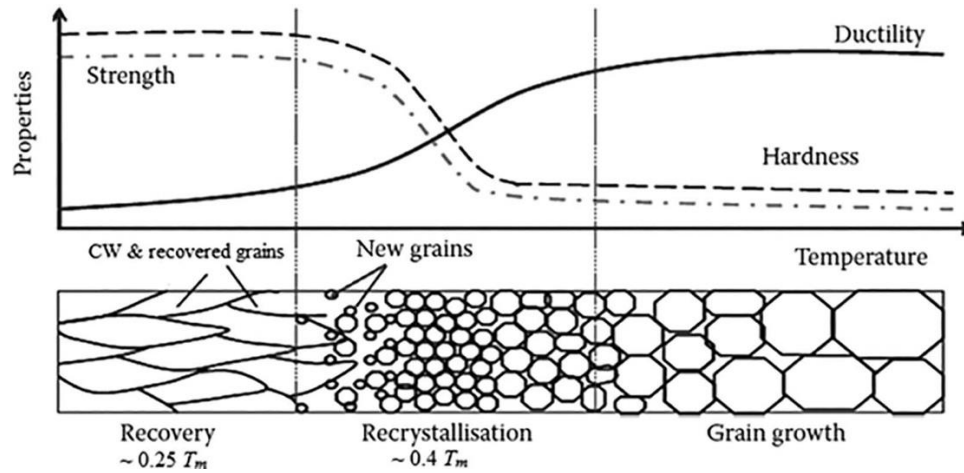

Figure 3: Schematical representation of the alterations in the structure and the properties of the material as a result of cold working and annealing [4].

3. EXPERIMENTAL STUDIES

Tools, Devices and Materials

1. Rolled Al samples (1xxx series)
2. Furnace
3. Optical microscope
4. Vickers hardness measurement device

Experimental Procedure

- Samples that are cold worked by the rolling process with different deformation amounts are prepared metallographically.
- Microstructures of the samples are examined and their grain size and hardness values are determined.
- Recrystallization annealing is applied to samples at the temperatures of 100 °C and 150 °C for 60 and 90 minutes.
- Microstructures of the samples that are metallographically prepared after the recrystallization are examined and their grain size and hardness values are determined.

4. RESULTS AND DISCUSSION



2022-2023 Spring MSE3952 Laboratory II
Experiment 8: Recrystallization

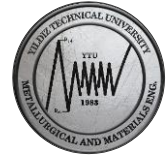

As a result of the experiments, the alterations that the recrystallization annealing may provide in the grain structure and the hardness of the cold worked materials may be observed. Also the effects of the deformation amount, annealing time and temperature on the recrystallization process are determined.

5. REFERENCES

- [1] D. Askeland, *Essentials of Materials Science and Engineering*, 2nd ed. 2010.
- [2] “Nevşehir Hacı Bektaş Veli University Materials Laboratory Experiment Booklet,” 2014.
- [3] R. E. Smallman and A. H. W. Ngan, *Modern Physical Metallurgy*. Elsevier, 2014. doi: 10.1016/C2011-0-05565-5.
- [4] Z. Huda, *Metallurgy for Physicists and Engineers: Fundamentals, Applications, and Calculations*, 1st ed. CRC Press, Taylor & Francis Group LLC., 2020.

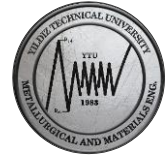

EXPERIMENT 9: HARDENING

1. PURPOSE OF THE EXPERIMENT: Investigation of the effect of cooling systems in hardening heat treatment applied to different types of steels on the microstructure and hardness of steels.

2. THEORETICAL KNOWLEDGE

2.1 Steels According to Alloy

- **Non-Alloy Steels:** The structure is Fe-C. There are small amounts of P,S,N,Si and Mn.
- **Low Alloy Steels:** (Mn,Si,W,V,Ti, etc.). Their total amount is below 2%.
- **Medium Alloy Steels:** Medium alloy steels between 2-5%.
- **High Alloy Steels:** The total of these substances is over 5%

2.2 Effects of Alloy Elements on Steel

1) Effect of Carbon Element It is the main element that has a hardening effect in steel. Increases hardness and tensile strength. However, it negatively affects the forging and weldability properties.

2) Effect of the Chromium Element Increases the corrosion resistance, hardening properties and wear resistance of the steel. It provides resistance at high temperatures. An increase of 8-10 kg/mm² is seen in the tensile strength of the steel against a 1% increase in chromium.

3) Effect of Nickel Element Increases the strength of steel without reducing its ductility. Nickel increases the notch impact resistance of structural steels, especially at low temperatures.

4) Effect of Manganese Element Improves the strength of steel. Slightly reduces its flexibility. Increases forging and weldability. The hardness and strength-enhancing feature of manganese depends on the amount of carbon. It also increases the quenching depth.

5) Effect of Silicon Element It is used as an important oxygen remover in steel making. When added to very low alloy carbon steel, a brittle material with high magnetic ability is obtained. The reason why silicon is used together with other alloying elements such as manganese, chromium and vanadium is to stabilize the carbides in the steel's structure.

6) Effect of Molybdenum Element **Molybdenum** is used alone in very few steels, but it is commonly used in combination with nickel, chromium or both. It increases the tensile strength, heat resistance and weldability of the steel. The high amount of molybdenum makes it difficult to forge the steel. Molybdenum is used in tool steels because it creates strong carbide when combined with carbon.

7) Effect of Vanadium Element **Vanadium** gives steel a wide range of hardening possibilities. It increases the resistance of steel to high temperatures. It is very difficult to soften vanadium steels by tempering. Therefore, it is widely used in tool steels.

8) Effect of Tungsten (Wolfram) Element It is widely used in tool steels. It increases the hardness and toughness of steel.

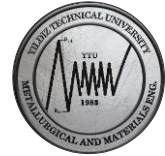

9) Effect of Cobalt Element Prevents grain growth at high temperatures. Increases heat resistance and wear resistance. It is mostly used in tool steels.

10) The Effect of Sulfur Element It is not desired to be present in any steel, except for free cutting steels. It makes steel brittle. The effect is minimized by adding manganese.

11) Effect of Aluminum Element It is used to control grain size during heat treatment and hot forming of steel. Since aluminum increases aging resistance, it is used to some extent in deep drawing sheets.

12) Effect of Element Phosphorus It makes steel brittle like sulfur. Except for automat steels, it is required to be at minimum level for other steels.

13) Effect of Oxygen Element It is more common in boiling steel types and creates danger with the oxide residues it creates.

14) Effect of Copper Element Increases the yield and tensile strength of steel. But it reduces its elasticity. It does not affect the weldability of the steel. It is used to increase the corrosion resistance of steel. The amount of copper in the steel is between 0.2% and 0.5%.

15) Effect of Nitrogen Element Increases the strength and hardness of steel. It facilitates the machining process. But it makes steel brittle. It forms nitrate when used with aluminum. Strength and toughness improve.

16) Effect of Hydrogen Element It is an element that is not desired to be found in steel. It comes the steel from used scrap, additives or moisture in the air. It reduces the fatigue resistance of steel.

3. HARDENING

It is the process of forming a partially C-side elongated tetragonal volume-centered martensite from KYM austenite, which contains dissolved carbon atoms in the lattice structure, by preventing the ferrite+pearlite transformation as a result of slow cooling, with rapid cooling, in the KHM lattice at room temperature, containing carbon in the middle of the edge..

3.1 How is hardening done?

The hardening process is the process of firstly heating the steel part to the austenite phase temperature and keeping it at this temperature for a certain period of time and rapidly cooling it at an appropriate rate. It determines that it reaches a homogeneous structure in the austenite phase, and this time varies depending on the chemical composition of the steel. The steel part, which has been kept for a sufficient time to ensure homogeneity at the austenite phase temperature, turns into martensite if it is cooled at high speed.

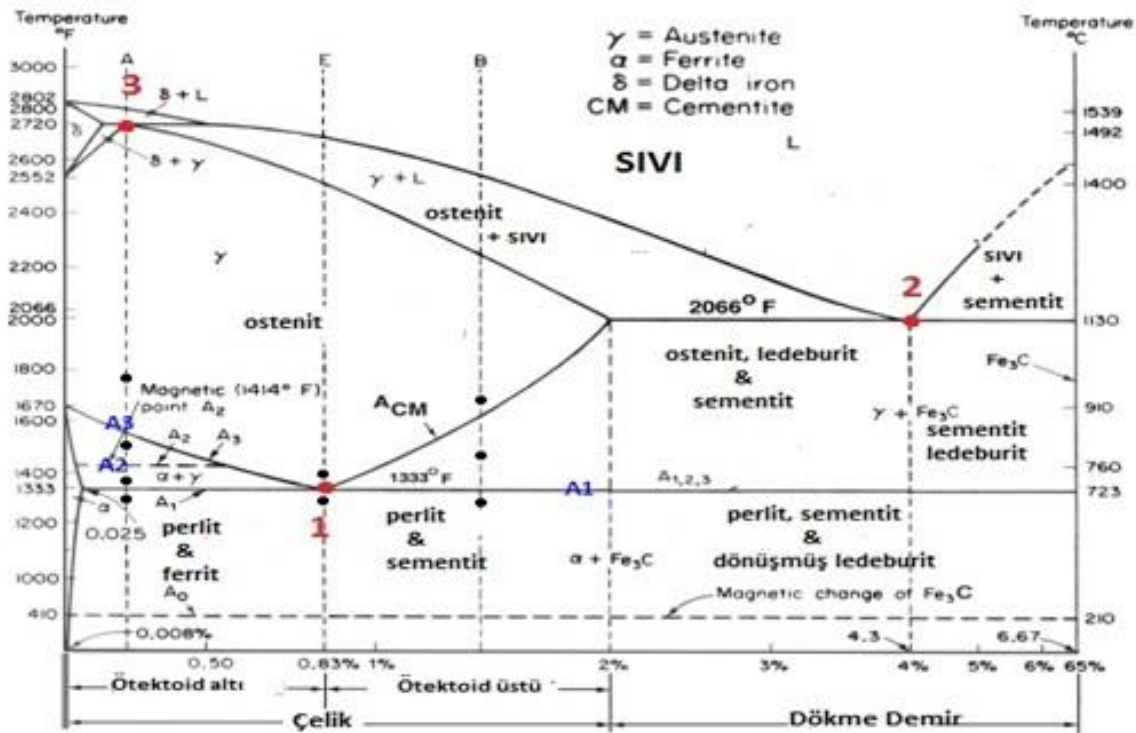

Figure 1. Iron-carbon equilibrium diagram

During the transformation, the crystal structure of the steel changes from face-centered cubic to volume-centered tetragonal crystal structure. The ratio (c/a ratio) in the dimensions of the volume-centered tetragonal crystal is ordered depending on the increase in the carbon content in the chemical composition of the steel. The basis of martensite hardness is this change in the crystal structure of the steel. There are several important characteristics of the austenite to martensite transformation.

- Transformation is the result of a sliding action, not by diffusion.
- There is no change in its chemical composition.
- Conversion depends only on temperature reduction. If cooling stops, it stops in transformation.

3.2 Cooling Process for Hardening

The cooling of a steel from the austenitization temperature can be practically explained with time-temperature-transformation diagrams, in these diagrams it is given depending on the time and temperature in the transformation state. This type of diagrams are called TTT diagram (Time-Temperature-Transformation) or S ergi in American literature. S melt; If the austenite transformation occurs at a certain temperature, it is the graph showing the relationship and transformation products between the times when the austenite begins to decompose and the decomposition completes at various temperatures, and the temperature

Isothermic Transformation: The transformation that occurs at a constant temperature is called isothermal transformation. The basis of transformation; the austenitization temperature of the steel is to be suddenly cooled to a constant temperature where isothermal freezing will occur, and to keep it at this temperature until the desired transformation is completed, and then to leave the part to cool down to room temperature again.

Continuous Cooling: It is a method of continuous cooling at various speeds. Unlike isothermal cooling, in continuous cooling, the core temperature of the austenitized steel is continuously reduced from the austenitized temperature to approximately room temperature by immersing the piece in the cooling medium, which is usually at room temperature. If the cooling is fast, martensite structure is formed, if it is slow, perlite-ferlite structure is formed.

3.3 Structures Formed by Isothermic Transformation

Perlite: It is formed from austenite isothermally, that is, with the increase of time at constant temperature. perlite; It is the product of the separation at temperatures (540°C) between the austenite A_1 and the nose of the TTT diagram.

Bainite: Both perlite and bainite occur around the nose of the TTT diagram. The isothermal transformation product of austenite at temperatures below the nose area and above the M_s point is bainite. Bainite transformation occurs at temperatures between 235°C and 550°C. This structure is different from the pearlitic structure and has a needle-like appearance. Like perlite in bainite, it is a very tight mixture of ferrite and cementite. The bainite structure is not lamellar as in perlite, but spherical. Because the carbide particles are dispersed as spheroids in the ferrite in this structure.

Martensite: It is the transformation product of austenite at temperatures below 225°C (M_s temperature). Martensite appears needle-like under the microscope.

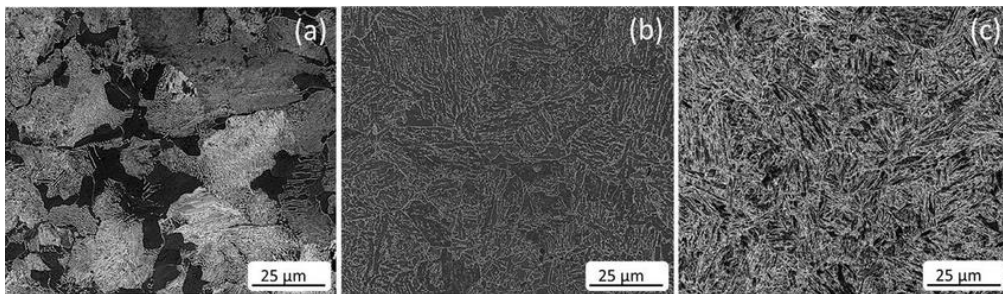

Figure2. ferrite-perlite, bainite, tempered-martensite

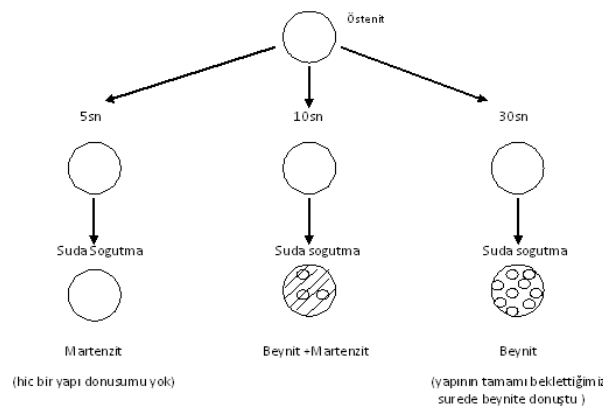

Figure3. Structure transformation from austenite



3.4 Cooling media for Hardening

The media used; water, oil, water with polymer additives, air, brine, salt baths, fluidized bed furnaces Their cooling rates are different from each other. The fastest cooling occurs in salt water.

cooling rate:

- Type of cooling medium
- Mixing of the cooling medium
- Temperature of the cooling medium
- Part size affects

4. Deneysel çalışmalar

4.1 Tools, Devices and Materials Used

- Muffle furnace
- Low, medium and high alloy steel parts
- Cooling assemblies
- Sanding, polishing and etching equipment
- Optical microscope
- Hardness device

4.2 Experimental Procedure

According to the amount of carbon it contains, the steel material is heated up to the austenite zone (on the AC3 line) and kept at the determined temperature for 1 hour. Then the metal parts are taken from the furnace and cooled in 3 different environments: in air, water and oil. As a result, 3 different parts are cooled in 3 different cooling environments, and a total of 9 parts are subjected to sample preparation processes and their microstructures are examined under an optical microscope. It is examined and evaluated how the microstructures change according to the material type and cooling environment. The measurement of the hardness changes of the samples is made with the Rockwell hardness device from 3 different parts of the sample.

5. Homework

- Interpretation of the effect of cooling medium and alloy amount on hardness and microstructure,
- Interpretation of the relationship between the obtained microstructures and hardnesses,
- Drawing hardness graphs.